

服务热线 Service Hotline

400-110-5088



NINGBO YUSHU FUJI ELEVATOR

精湛技艺 创新出行
Excellent Skills, Innovative Travel

中国·宁波御墅富士电梯有限公司
CHINA NINGBO YUSHU FUJI ELEVATOR CO., LTD.

- 中国·宁波杭州湾新区滨海三路508号
No. 508, Binhai 3rd Road, Hangzhou Bay New District, Ningbo, China
- 0574-63446999 0574-63041687
- 0574-63517917 www.nbfuji.com

扫描二维码,
查看宁波御墅富士电梯官方网站
Scan the QR code to view the official website of
Ningbo Yushu Fuji Elevator Co., Ltd.

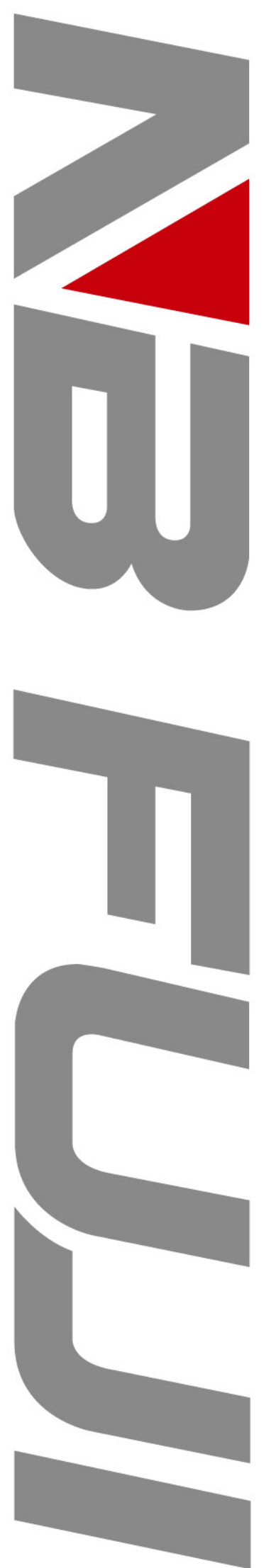

EXTRAORDINARY TRAVEL, INTELLIGENT FUTURE

出行不凡, 智创未来

NB FUJI

我们坚持的, 不止是精工品质, 更是优质的乘行体验,
我们追求的, 不止是尖端技术, 更是人性化的科技美,
质感、美感、高级感……

从细节到整体,

从过去到未来,

宁波御墅富士电梯, 出行不凡, 智创未来

What we insist on is not only the exquisite craftsmanship quality,
but also the high-quality riding experience,

What we pursue is not only the cutting-edge technology, but also
humanized technological beauty.

Quality, beauty, high-grade sense...

From the details to the whole,

From the past to the future,

Ningbo Yushu Fuji elevator aims to provide extraordinary travel,
and intelligent future

LONG HISTORY CRAFTSMAN SPIRIT AND INTELLIGENCE

源远流长的匠魂智心

精诚·质感·体验

Sincerity · Quality · Experience

回顾过往，正视现在，预见未来

宁波御墅富士电梯的斐然业绩都源自于卓越传承和创新变革的相互交融。

在源远流长的成长中，宁波御墅富士电梯坚信工匠精神的强大生命力，沿承日本大工业时代一直以来的匠心灵魂、职人理念和精湛技艺，创造了一件件呈现生活质感的非凡杰作。

同时，宁波御墅富士电梯以持续的技术创新，预见市场发展，洞察生活所需，以科技美学精品诠释新生代典范，在当今乃至未来智慧化时代表现得游刃有余。

Look back on the past, face up to the present, foresee the future.

The outstanding performance of Ningbo Yushu Fuji elevator is derived from the integration of excellent inheritance and innovation and transformation.

In the long history of growth, Ningbo Yushu Fuji elevator firmly believes in the strong vitality of the craftsman spirit, inherits the spirit of craftsmanship, the concept of professionals and excellent skills in the Japan's Great Industrial Era, and it has created extraordinary masterpiece that present the quality of life.

At the same time, with continuous technological innovation, Ningbo Yushu Fuji elevator foresees market development, insights into the needs of life, and interprets the new generation model with high-tech aesthetics, performing well in the current and future intelligent era.

大智所驱，技领未来

作为高品质电梯服务的引领者，极富前瞻思维和责任情怀的宁波御墅富士电梯开始新的进化之旅，以更人性、环保和智慧的解决方案服务城市生活，为社会带来高品位的美好体验。

Driven by great wisdom, technology leads the future

As a leader in high-quality elevator services, Ningbo Yushu Fuji elevator, which is full of forward-looking thinking and responsible feelings, has begun a new evolutionary journey, to serve urban life with more humane, environmentally friendly and intelligent solutions, bringing high-class experience to society.



不仅拥有领先的自动化设备，更通过先进的制造平台，让效率、品质相得益彰。

宁波御墅富士积极打造集智能安全节能于一体的智造，引进国际先进电梯技术和生产工艺，数字化科学统筹管理，实现精益生产，从而为客户提供高品质的楼宇交通解决方案。

Ningbo Yushu Fuji elevator not only has the leading automation equipment, but also complement efficiency and quality each other through advanced manufacturing platform.

Ningbo Yushu Fuji elevator actively builds intelligent manufacturing integrating intelligence, safety and energy saving, introduces international advanced elevator technology and production technology, digital and scientific overall management, to realize lean production, so as to provide customers with high-quality building transportation solutions.



WORLD-CLASS, INDUSTRY-LEADING AND INTELLIGENT MANUFACTURING BASE

世界一流、行业领先的智造基地

自动化·数字化·智能化
Automation · Digitization · Intelligence

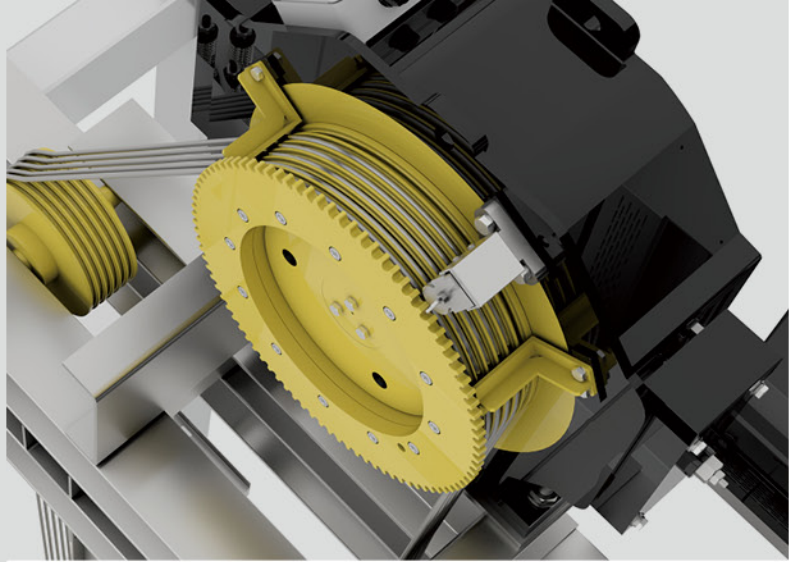

高性能主机

新一代永磁同步无齿轮主机, 主机拖动能力和制动力矩优于国标要求, 确保电梯可靠运行。

High performance host

The drag capacity and braking torque of new generation of permanent magnet synchronous gearless mainframe are better than the national standard requirements, ensuring reliable operation of the elevator.



智能光幕保护

高光束光幕系统, 灵敏、高效、精准, 确保人身安全的同时能够自动检测故障位置, 为快速解决光幕问题提供依据。

Intelligent light curtain protection

The high-beam light curtain system is sensitive, efficient, and accurate. It can automatically detect the fault location while ensuring personal safety, providing a basis for quickly solving the light curtain problem.

UCMP保护系统

当电梯处于平层位置且开门状态下, 如果出现意外移动, UCMP 保护装置将会立即启动, 使电梯安全制停, 防止出现意外。

UCMP protection system

When the elevator is in the leveling position and the door is opened, if there is an accidental movement, the UCMP protection device will immediately start to make the elevator stop safely to prevent accidents.

32位DSP处理器

性能升级的控制系统采用高性能 32 位 DSP 处理器, 具有强抗干扰能力, 全面提升系统的响应速度与可靠性。

32 bit DSP processor

The performance-upgraded control system adopts a high-performance 32-bit DSP processor, which has strong anti-interference ability to comprehensively improve the system's response speed and reliability.

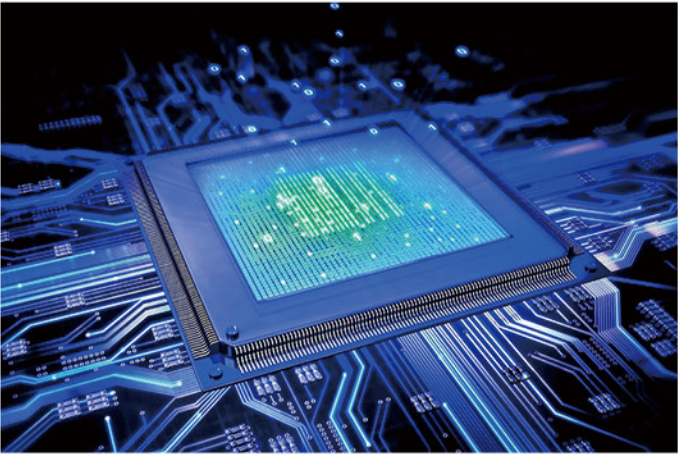

VARIOUS GUARANTEE TO KEEP EASE AND COMFORTABLE

重重防护, 安心自如



ONE-BUTTON FOR INTELLIGENCE, LOVE AT FIRST SIGHT

一键智能，一见倾心

无接触智慧呼梯

用户可通过手机 APP 提前预约呼梯，既节约候梯时间，又减少与其他用户的间接接触，防止交叉感染。

Contactless and intelligent elevator-calling service

Users can book elevator-calling service in advance through the mobile APP, which not only saves waiting time, but also reduces indirect contact with other users and prevents cross-infection.



智能识别权限管理

系统根据事先录入信息，通过人脸识别等方式对业主开放专属楼层用梯，需身份确认后用梯，有效提升住户的私密性与安全性。

Management on intelligent recognition authority

Based on the information entered in advance, the system opens exclusive floor elevators to owners through face recognition and other methods. The elevators are used after identification is confirmed, which effectively improves the privacy and safety of residents.



楼宇智能管理系统

采用 IC 卡智能识别系统，建立大数据系统，精准管理住户的出行安全。

Intelligent management system of building

The management system adopts IC card's intelligent identification system and establishes a big data system to accurately manage the travel safety of residents.

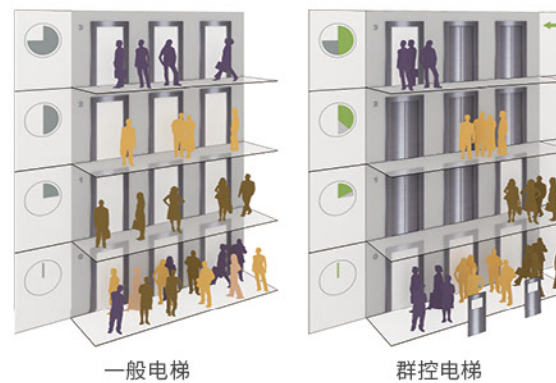

智能派梯系统

为解决人流密集型场所高效乘行问题，运用智能群控派梯系统，优化电梯运行机制，从而大大缩短候梯时间，提升大楼运行效率。

Intelligent elevator-dispatching system

To solve the problem of efficient riding in crowded places, the intelligent group control elevator dispatching system is used to optimized the elevator operation mechanism, greatly shortening the waiting time and improving the operating efficiency of the buildings.

OPTIMIZE SPACE, AND INCREASE VALUE

优化空间, 提升价值

小机房电梯 小巧大用, 运载自如

- 高效空间利用, 提升建筑品质
- 简化安装流程, 缩短安装工期
- 合理沟通设计, 降低能源损耗

Small machine room elevator
High-efficient use with small space for free travel

- Make efficient use of space to improve building quality
- Simplify the installation process and shorten the installation
- Reasonably communicate design to reduce energy consumption

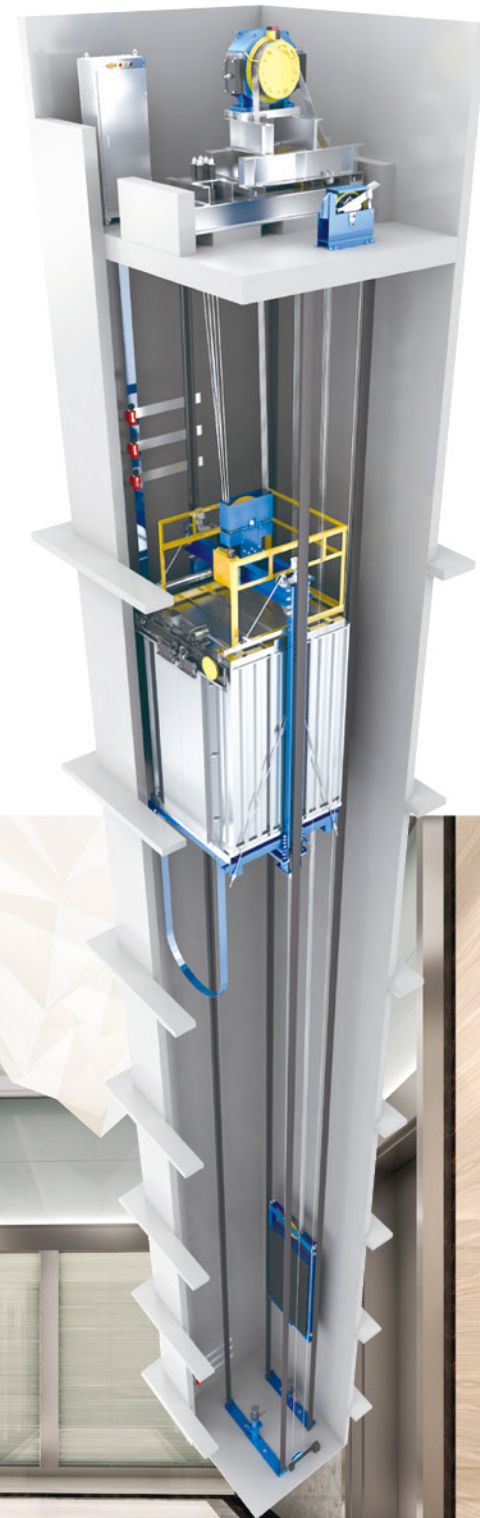

30%

高效节能30%
High efficiency and 30%
energy saving

40⁺%

机房面积缩小40%以上
Machine room area
shrinks more than 40%

无机房电梯 无拘无束, 无限可能

- 无需设置主机机房, 极大节约了建筑成本
- 优化建筑空间, 为建筑设计提供更多可能
- 无需预留复杂洞口, 土建要求更简单

Machine roomless elevator
Unlimited possibilities

- No need to set up a host machine room, which greatly saves construction costs
- Optimize the building space and provide more possibilities for architectural design
- No need to reserve complex holes, and the civil construction requirements are simpler

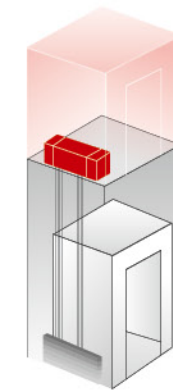

小机房电梯
Small machine room
elevator

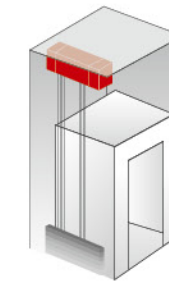

无机房电梯
Machine roomless
elevator

10%

节约建筑面积
It saves 10% of the
building area

40%

节约电能
It saves 40% of the
electric energy

25⁺%

提高效率25~30%
It enhances 25~30%
of the efficiency

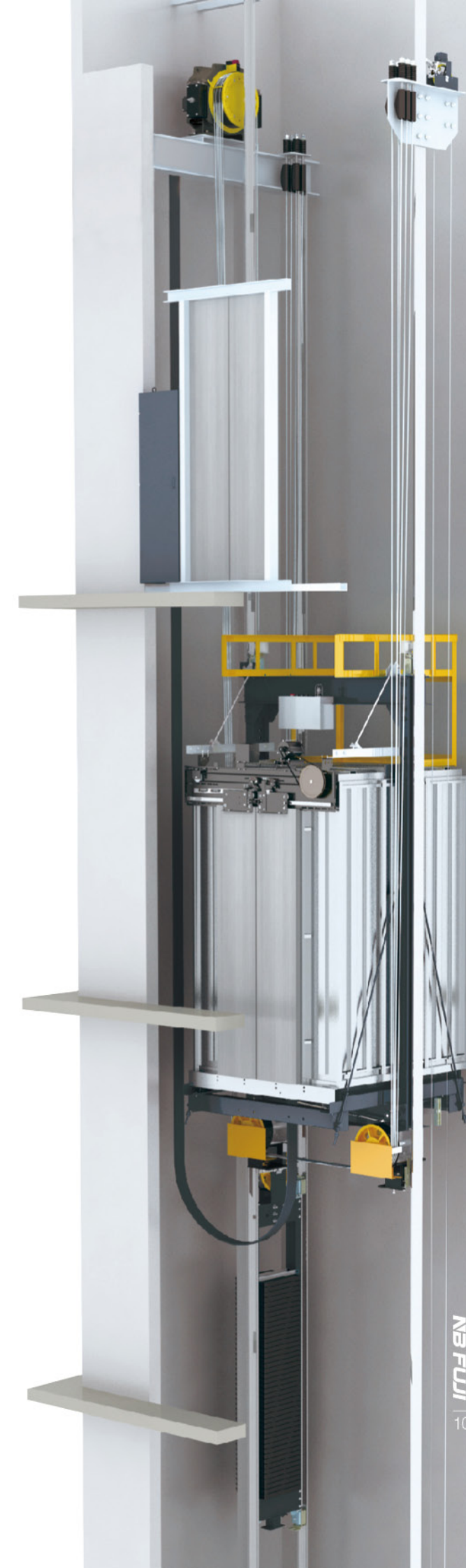

STANDARD CAR CONFIGURATION

乘客电梯标准轿厢



轿厢 360°全景展示



轿厢 360°全景展示

NB-P01 标准轿厢 Standard Car

吊顶: 发纹不锈钢, 亚克力板, LED 节能灯 (NB-C01) 轿壁: 发纹不锈钢, 后壁镜面蚀刻 地板: 大理石地板 (NB-F01)
 Ceiling: Hairline stainless steel, acrylic board, LED energy saving lamp(NB-C01) Car wall: Hairline stainless steel, rear wall mirror etching
 Floor: Marble floor

图片系电脑绘制, 可能与实物略有不同。
 The picture is drawn by computer, which may be slightly different from the final product.

操纵箱、外呼 (标配)

COP&LOP(Standard)



NB-COP-01

一体式操纵箱
 Integrated COP

图片系电脑绘制, 可能与实物略有不同。
 The picture is drawn by computer, which may be slightly different from the final product.



消防开关
 Fire switch



NB-LOP-01

无底盒
 Without bottom case

操纵箱设计

COPdesign

NB-COP-01

面板: 发纹不锈钢
 显示: 7 寸图片机
 Surface: Hairline stainless steel
 Display: 7-inch picture machine

外呼设计

LOPdesign

NB-LOP-01

面板: 发纹不锈钢
 显示: 4.3 寸段码液晶显示
 Surface: Hairline stainless steel
 Display: 4.3' Segment code LCD

厅门 (标配)

Landing door(Standard)



NB-D01

首层发纹不锈钢, 其余楼层钢板喷涂
 First landing door hairline stainless steel, other doors painted steel.

OPTIONAL CAR CONFIGURATION

乘客电梯选配轿厢

NB-P02

吊顶: 不锈钢板, 亚克力透光板, 高效节能 LED 灯饰 (NB-C02)
轿壁: 发纹不锈钢, 镜面蚀刻
扶手: 发纹不锈钢 (NB-H01)
地板: 大理石地板 (NB-F01)

Ceiling: Stainless steel plate, acrylic transparent panel, energy-efficient LED lighting(NB-C02)
Car wall: Hairline stainless steel, mirror etching
Handrail: Hairline stainless steel (NB-H01)
Floor:Marble floor(NB-F01)



轿厢 360°全景展示



NB-P03

吊顶: 不锈钢板, 亚克力透光板, 高效节能 LED 灯饰 (NB-C02)
轿壁: 发纹不锈钢, 镜面蚀刻
扶手: 发纹不锈钢 (NB-H01)
地板: 大理石地板 (NB-F01)

Ceiling: Stainless steel plate, acrylic transparent panel, energy-efficient LED lighting(NB-C02)
Car wall: Hairline stainless steel, mirror etching
Handrail: Hairline stainless steel (NB-H01)
Floor:Marble floor(NB-F01)



轿厢 360°全景展示



< NB-P04

吊顶: 中间发纹不锈钢框白色透光板柔光照明设计、两侧发纹不锈钢 (NB-C03)
轿壁: 两侧发纹不锈钢, 后壁中间镜面蚀刻不锈钢
扶手: 发纹不锈钢 (NB-H01)
地板: 大理石地板 (NB-F01)

Ceiling: Hairline stainless steel frame in middle, white transparent board on both sides of the soft lighting design, two sides made of stainless steel(NB-C03)
Car wall: Two sides made of hairline stainless steel, the middle of the wall mirror etching stainless steel
Handrail: Hairline stainless steel (NB-H01)
Floor:Marble floor(NB-F01)



轿厢 360°全景展示



NB-P08 >

吊顶: 不锈钢板, 亚克力透光板, 高效节能 LED 灯饰
轿壁: 镜面不锈钢, 镜面蚀刻
地板: PVC 地板

Ceiling: Stainless steel plate, acrylic transparent panel, energy-efficient LED lighting
Car wall: Mirror stainless steel, mirror etching
Floor: PVC floor



轿厢 360°全景展示

< NB-P14

吊顶: 发纹不锈钢板, 亚克力板, LED 节能灯 (NB-C01)
轿壁: 发纹不锈钢, 镜面蚀刻
扶手: 发纹不锈钢 (NB-H01)
地板: 大理石地板 (NB-F01)

Ceiling: Hairline stainless steel plate, acrylic plate, LED energy-saving lamp (NB-C01)
Car wall: Hairline stainless steel, mirror etching
Handrail: Hairline stainless steel (NB-H01)
Floor:Marble floor(NB-F01)



轿厢 360°全景展示

图片系电脑绘制, 可能与实物略有不同。

The picture is drawn by computer, which may be slightly different from the final product.

NB-P16 >

吊顶: 镜面不锈钢 + 亚克力
轿壁: 发纹不锈钢 + 镜面蚀刻不锈钢
扶手: 发纹不锈钢圆管
地板: PVC

Ceiling: mirror stainless steel + acrylic
Car wall: hairline stainless steel + mirror etching stainless steel
Handrail: hairline stainless steel round
Floor: PVC



轿厢 360°全景展示

图片系电脑绘制, 可能与实物略有不同。

The picture is drawn by computer, which may be slightly different from the final product.



< NB-P18

吊顶: 玫瑰金镜面不锈钢 + 亚克力
轿壁: 玫瑰金发纹 + 玫瑰金镜面不锈钢
扶手: 不锈钢圆管镀玫瑰金
地坪: PVC

Ceiling: Rose-gold Mirror ST.ST. + Acrylic
Car Wall: Rose-gold Hairline ST. ST. + Rose-gold Mirror ST.ST.
Handrail: Rose Gold Round ST.ST. Tube
Flooring: PVC

NB-P05 >

吊顶: 黑钛不锈钢框架, 亚克力透光板
轿壁: 镜面, 黑钛镜面不锈钢, 镜面蚀刻
扶手: 不锈钢圆扶手
地板: PVC 地板

Ceiling: Black titanium stainless steel frame, acrylic light-passing board
Car wall: Mirror, black titanium mirror stainless steel, mirror etching
Handrail: Stainless steel round handrail
Floor: PVC floor



轿厢 360°全景展示



轿厢 360°全景展示



< NB-P09

吊顶: 不锈钢框架, 筒灯, 中间透光板
轿壁: 镜面不锈钢, 木纹钢板
扶手: 不锈钢实木组合
地板: 大理石地板

Ceiling: Stainless steel frame, downlight, transparent plate
Car wall: Mirror stainless steel, wood plate
Handrail: Stainless steel solid wood combination
Floor: Marble floor

NB-P10 >

吊顶: 不锈钢框架, 中部造型顶板
轿壁: 发纹不锈钢, 实木面板, 镜面镶边
扶手: 造型扶手
地板: PVC 地板

Ceiling: Stainless steel frame, central shape top board
Car wall: Hairline stainless steel, wood panels, mirror edge
Handrail: Modelling handrail
Floor: PVC floor



轿厢 360°全景展示



轿厢 360°全景展示



< NB-P17

吊顶: 钛金镜面不锈钢
轿壁: 钛金板及镜面不锈钢
扶手: 钛金三管扶手
地板: PVC

Ceiling: Titanium Mirror stainless steel
Car Wall: Titanium ST. ST. + Titanium Mirror ST.ST.
Handrail: Titanium three pipes handrail
Floor: PVC

NB-P12 >

吊顶: 钛金镜面不锈钢, 白色透光板
轿壁: 钛金发纹不锈钢, 镜面蚀刻
扶手: 实木与钛金组合
地板: 大理石拼花地板

Ceiling: Titanium mirror stainless steel, middle white transparent board
Car wall: Titanium hairline stainless steel, mirror etched
Handrail: Solid wood and titanium combination
Floor: Marble parquet floor



轿厢 360°全景展示



轿厢 360°全景展示



< NB-P11

吊顶: 四周边框为金属烤漆, 暗藏灯带, 上层中间镜面蚀刻, 四周烤金属漆
轿壁: 中间木纹钢板, 两侧木纹石饰面, 木纹石饰面, 镜面不锈钢
扶手: 实木圆扶手
地板: 木纹石地

Ceiling: Metal frame with baking paint and hidden lights; mirror etched ceiling with metal frame of baking paint
Car wall: Wood plate in the middle with serpeggiant decorations on both sides, Serpeggiant, mirror stainless steel
Handrail: Solid wood round handrail
Floor: Serpeggiant floor

NB-P19 >

吊顶: 长发纹不锈钢镀古铜 + 镜面不锈钢镀古铜 + LED 筒灯 + 暗藏灯
轿壁: 长发纹不锈钢镀古铜 + 镜面不锈钢镀古铜 + 镜面不锈钢蚀刻镀古铜
扶手: 长发纹不锈钢镀古铜
地板: 拼花石材

Ceiling: long hairline stainless steel plated in titanium bronze + mirror finished stainless steel plated in titanium bronze + LED down light + hidden lamp
Car wall: long hairline stainless steel plated in titanium bronze + mirror finished stainless steel plated in titanium bronze + etched mirror stainless steel plated in titanium bronze
Handrail: long hairline stainless steel plated in titanium bronze
Floor: parquet stone



轿厢 360°全景展示



轿厢 360°全景展示



BE RESPONSIBLE FOR LIFE, DESIGN FOR LOVE

为生命负责, 为爱设计

医用电梯

宁波御墅富士电梯深刻洞察医院场景, 为病患和医护人员提供细致入微的关怀设计, 以卓越的品质和强大的运载功能创造高效、安全的健康通道。

Hospital elevator

Ningbo Yushu Fuji elevator has a deep insight into the hospital scene, provides meticulous care design for patients and medical staff, and creates an efficient and safe healthy passage with excellent quality and powerful carrying functions.

多种开门方式

Multiple door open modes

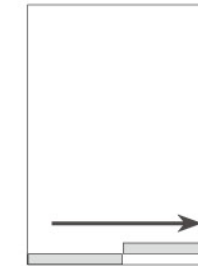

单通门
Single way door

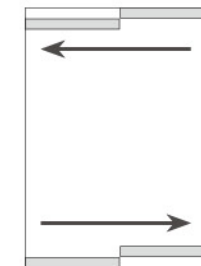

交叉开门
Crossed door opening

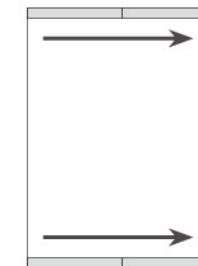

贯通门
Double ways door

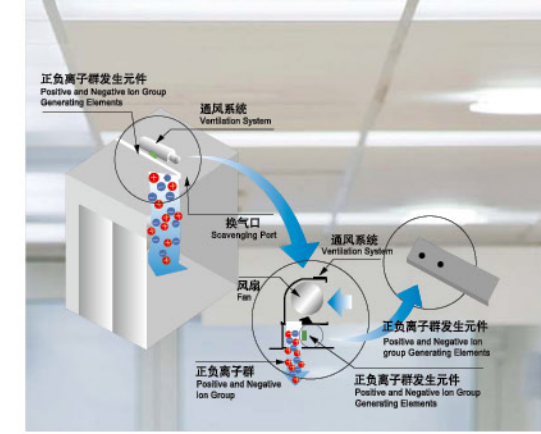

NB-Y01

标准轿厢

Standard Car

吊顶: 发纹不锈钢, 亚克力板, LED 节能灯

轿壁: 发纹不锈钢

轿门: 发纹不锈钢

扶手: 不锈钢扁扶手 (两侧)

照明: LED 筒灯

地板: 大理石

Ceiling: Hairline stainless steel, acrylic board, LED energy saving light

Car wall: Hairline stainless steel

Car door: Hairline stainless steel

Handrail: Hairline stainless steel flat handrail (Both sides)

Lighting: LED down light

Floor: Marble



轿厢 360°全景展示

图片系电脑绘制, 可能与实物略有不同。

The picture is drawn by computer, which may be slightly different from the final product.

VIEW THE SCENE IN 360 DEGREE

一览无遗，自成风景

观光电梯

宁波御墅富士观光电梯集美学、品味、舒适为一体，全景式设计，在城市建筑空间中自成风景。

Panoramic elevator

Panoramic elevator in Ningbo Yushu Fuji elevator company integrates aesthetics, taste and comfort, creating a landscape in the urban architectural with a panoramic design.



风格美学设计

专业的外观和结构设计团队，匹配每个空间的建筑风格，营造赏心悦目的乘行体验。

Style aesthetic design

The professional appearance and structure design team matches the architectural style of each space to create a pleasing ride experience.

玻璃钢结构外罩

采用高精度玻璃钢材料，令电梯外型美观，与建筑及周围环境融为一体，展现出空间的紧凑和整体风格的通透。

FRP structure cover

The use of high-precision glass fiber reinforced plastic materials makes the elevator beautiful in appearance, and integrated with the building and the surrounding environment, showing the compactness of the space and the transparency of the overall style.



多角度梯外景观

凭借平稳舒适的乘坐感觉和多种角度的梯外景观，为用户带来新奇的观景享受。

Multi-angle landscape outside the elevator

With a smooth and comfortable ride and a variety of angles of landscape outside the elevator, it brings users a novel viewing experience.

多种轿厢形式供你选择，满足你不同需求

There are a variety of car types for you to choose to meet your different needs.

图中红色线条为透明玻璃。

The red line in the picture is transparent glass.

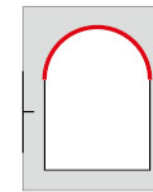

半圆型
Semi-circular shaped

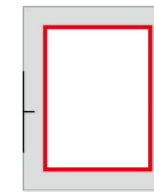

全观光方型
Full sightseeing
Square shaped

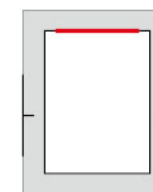

展望型
Panoramic

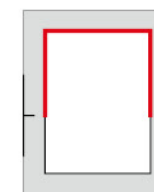

半观光方型
Semi-sightseeing
Square shaped

OPTIONAL CAR CONFIGURATION

观光电梯选配轿厢

NB-G01

上下罩: 钢板喷涂加装饰条
 观光壁: 夹胶安全玻璃三块
 吊顶: 白色顶灯加筒灯
 轿壁: 发纹不锈钢
 扶手: 不锈钢单管
 地板: PVC 地板

Upper/lower hood: Painted steel with decoration
 Observation wall: Three pieces of laminated glass
 Ceiling: White ceiling and down light
 Car wall: Hairline stainless steel
 Handrail: Single tube with stainless steel
 Floor: PVC floor



轿厢 360°全景展示



NB-G10

上下罩: 钛金镜面不锈钢
 观光壁: 夹胶安全玻璃
 吊顶: 钛金镜面不锈钢, 亚克力, LED 筒灯
 轿壁: 钛金镜面不锈钢
 扶手: 钛金不锈钢圆三联管
 地板: PVC 地板

Upper/lower hood: titanium golden mirror stainless steel
 Observation wall: laminated glass
 Ceiling: titanium gold mirror stainless steel + acrylic + LED downlights
 Car rear wall: titanium gold mirror stainless steel
 Handrail: titanium gold mirror stainless steel round triplex
 Floor: PVC



轿厢 360°全景展示



NB-G11

上下罩: 简易上下罩
 观光壁: 夹胶安全玻璃
 吊顶: 镜面不锈钢, 筒灯
 轿壁: 镜面不锈钢
 扶手: 发纹不锈钢圆扶手
 地板: PVC 地板

Upper/lower hood: simple upper and lower covers
 Observation wall: laminated glass
 Ceiling: Mirror stainless steel, acrylic
 Car wall: Mirror stainless steel
 Handrail: hairline stainless steel round
 Floor: PVC



轿厢 360°全景展示



NB-G12

上下罩: 简易上下罩
 观光壁: 夹胶安全玻璃
 吊顶: 镜面不锈钢, 亚克力, 筒灯
 轿壁: 发纹不锈钢
 扶手: 发纹不锈钢圆扶手
 地板: PVC 地板

Upper/lower hood: simple upper and lower covers
 Observation wall: laminated glass
 Ceiling: mirror stainless steel + acrylic + downlights
 Car wall: hairline stainless steel
 Handrail: hairline stainless steel round
 Floor: PVC



轿厢 360°全景展示



图片系电脑绘制, 可能与实物略有不同。
 The picture is drawn by computer, which may be slightly different from the final product.

图片系电脑绘制, 可能与实物略有不同。
 The picture is drawn by computer, which may be slightly different from the final product.

CUSTOMIZE YOUR IDEAL HOME

定制您的理想之家



智能家用电梯首选

融合高端艺术设计和前沿智能科技，时刻以您和家人为中心，全面提升家居生活品质和空间品味，定制属于您的理想之家。

The first choice for intelligent home elevators

With integrated high-end art design and cutting-edge intelligent technology, we always centers on you and your family, comprehensively improves the quality of home life and space taste, and customize your ideal home.

智能APP应用

自主开发家用电梯 APP 管理系统，通过手机即可完成调节灯光、智能呼梯、运行数据报告、预约维保、故障预警等功能。

Intelligent APP application

The functions on self-developed APP management system of home elevator, such as light adjustment, smart elevator-calling service, operation data report, maintenance appointment, fault warning, can be completed through the mobile phone.

多样化开门方式定制

根据电梯安装位置及使用便捷性，家用电梯的开门方式可选中分式、旁开式和手拉门，一切设计基于用户更好的体验。

Diversified door opening customization

According to the installation position and convenience for use, the gate opening ways of home elevator can be divided into side-opened type, center-opening type and hand sliding door for providing users with better experience.

中分式
Center-opening

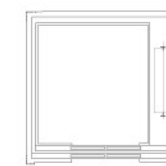

旁开式
Side-opening

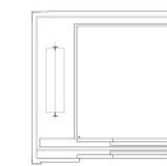

直角开门
Right-angled door

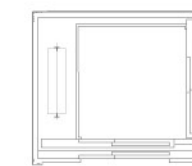

自动式
Automatic door

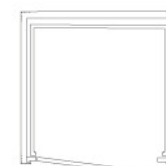

中分双折门
Center-opening & double-folded

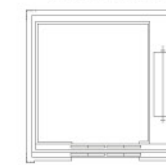

贯通门
Through type

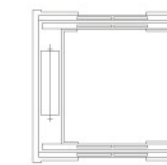

中分平开
Center-opening & side hung door

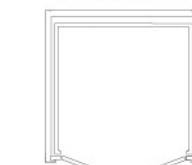

手拉式
Manually operated door

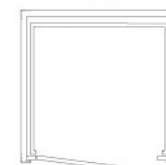

停电应急自救系统

当发生停电或突发故障时，电梯自救系统让别墅电梯低速运行至平层位置，安全释放乘客。

Emergency and self-rescue system in power failure condition

When power outage or sudden failure occurs, the elevator self-rescue system allows the villa elevator to run to the leveling position at low speed so as to safely rescue passengers.

云端故障修复功能

当电梯出现部分单一问题时，物联网平台将远程修复故障问题，节约维保时间，避免打扰业主生活。

Cloud fault repair function

When a single problem occurs in the elevator, the Internet of Things platform will repair the problem remotely, which saves maintenance time and avoid disturbing the life of the owners.

HOME ELEVATOR CAR CONFIGURATION

家用电梯轿厢装潢

NB-V01 标准轿厢 Standard Car

吊顶: 发纹不锈钢, 亚克力板, LED 节能灯 (NB-C01)
轿壁: 发纹不锈钢, 后壁镜面蚀刻
地板: PVC (NB-F01)

Ceiling: Hairline stainless steel, acrylic board, LED energy saving lamp (NB-C01)
Car wall: Hairline stainless steel, rear wall mirror etching
Floor: PVC (NB-C01)



轿厢 360°全景展示

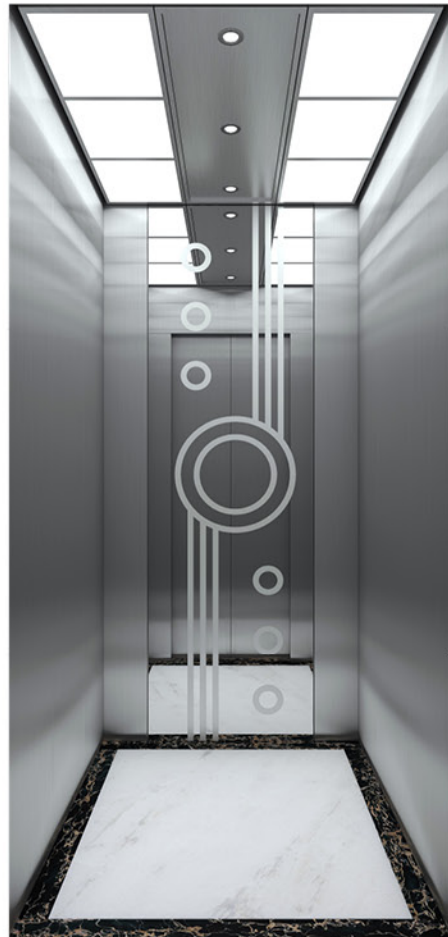

NB-V02

吊顶: 玫瑰金发纹不锈钢框架筒灯点缀, 中间玫瑰金镜面不锈钢板装饰, 中间四周 LED 灯带
轿壁: 左右玫瑰金发纹不锈钢, 后壁玫瑰金发纹不锈钢与玫瑰金镜面蚀刻不锈钢组合
地板: PVC

Ceiling: Decorated with down light that has rose gold pattern hairline stainless steel frame, rose gold mirror surface stainless steel plate in middle, and LED light belt surround the middle
Car wall: Rose gold pattern hairline stainless steel in the left and right, and combined with rose gold pattern hairline stainless steel with rose gold mirror surface etching stainless steel in the back wall
Floor: PVC



轿厢 360°全景展示



NB-V03

吊顶: 钛金镜面不锈钢框架, 中间 LED 透光板
轿壁: 镜面、蚀刻、钛金
地板: PVC

Ceiling: Titanium mirror stainless steel frame, the middle of the LED light transmission plate
Car wall: mirror, etching, titanium
Floor: PVC



轿厢 360°全景展示



NB-V07

吊顶: 香槟金不锈钢框架, 香槟金镜面蚀刻, 吸顶灯, LED 照明
轿壁: 香槟金喷砂不锈钢, 镜面蚀刻不锈钢
扶手: 香槟金不锈钢与实木组合
地板: 大理石

Ceiling: Stainless steel frame (champaign gold), mirror etching (champaign gold), absorb dome light LED lighting
Car wall: Champaign gold sandblasted stainless steel, mirror etching stainless steel
Handrail: Champagne stainless steel and solid wood combination
Floor: PVC



轿厢 360°全景展示



图片系电脑绘制, 可能与实物略有不同。
The picture is drawn by computer, which may be slightly different from the final product.

图片系电脑绘制, 可能与实物略有不同。
The picture is drawn by computer, which may be slightly different from the final product.

COP & LOP (OPTIONAL)

操纵箱、外呼 (选配)

NB-COP-02

面板：
发纹不锈钢
Surface:
Hairline stainless steel

NB-COP-03

面板：
钛金不锈钢
Surface:
Titanium gold stainless steel

NB-COP-04

面板：
玻璃触摸屏
Surface:
Glass touch screen

NB-COP-05

一体式操纵箱
Integrated COP
面板：
发纹不锈钢
Surface:
Hairline stainless steel

可选显示

Optional display

NB-XS01

10.4 寸图片显示
10.4inch
picture display



NB-XS02

10.4 寸视频显示
10.4inch
video display



NB-XS03

7 寸图片显示
7inch
picture display



NB-XS04

9.7 寸图片显示
9.7inch
picture display



NB-LOP-02A

单联 Simplex



NB-LOP-02B

并联 Duplex

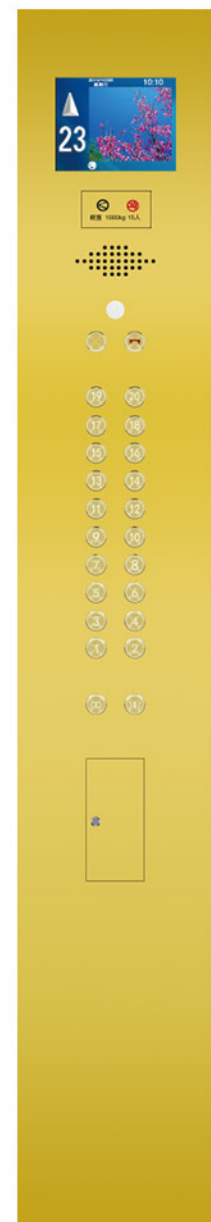

NB-LOP-03A

单联 Simplex



NB-LOP-03B

并联 Duplex

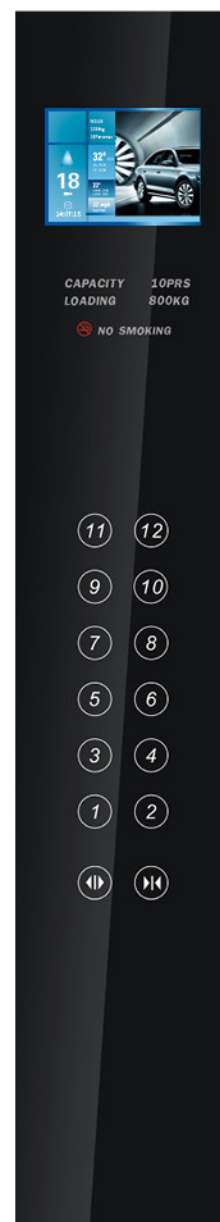

NB-LOP-04A

单联 Simplex



NB-LOP-04B

并联 Duplex

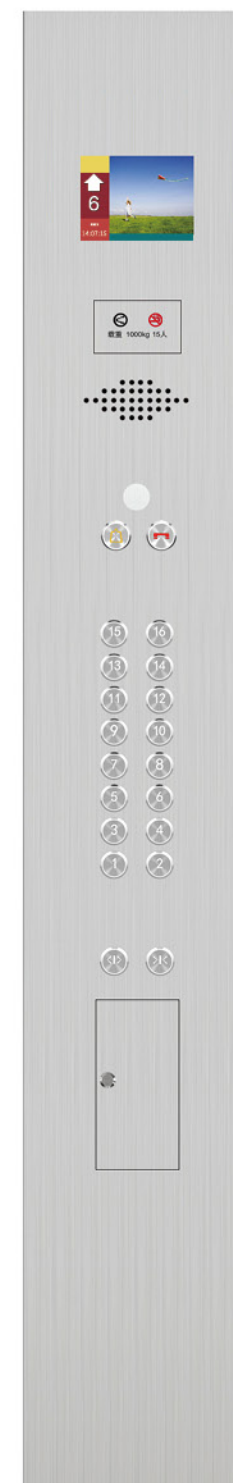
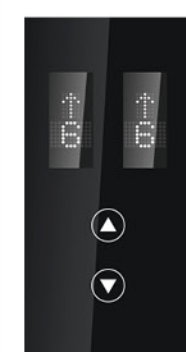

NB-LOP-05A

单联 Simplex



NB-LOP-05B

并联 Duplex



按钮 (选配)

Button(optional)

NB-B01

无底盒超薄
按钮带盲文
Ultrathin bottomless box
Button with braille



NB-B02

锌合金
圆形按钮
Zinc alloy
Round button



NB-B03

不锈钢
字钉按钮
Stainless steel
Nail type button



NB-B04

树脂透明
方形按钮
Transparent resin
Square button



厅外横显 (选配)

Horizontal hall display(optional)

NB-HX01

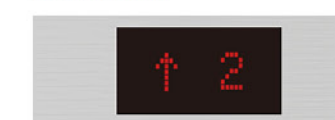

NB-HX02



NB-HX03



NB-HX04



OPTIONAL DECORATION

可选装潢

吊顶系列 (选配)

Ceiling series (optional)



NB-C04

镜面不锈钢, 节能灯
Mirror stainless steel, energy saving lamp



NB-C11

镜面不锈钢框架, 亚克力柔光照明设计
Mirror surfaced stainless steel made frame, acrylic soft light illumination design



NB-C12

镜面不锈钢框架, 亚克力柔光照明设计, 四侧筒灯
Mirror surface stainless steel made frame, acrylic soft light illumination design, down lamp around



NB-C13

发纹不锈钢框架, 亚克力, LED 筒灯
Hairline stainless steel frame, acrylic, LED downlight



NB-C14

镜面不锈钢框架, 中间影像线条透光板
Mirror surface stainless steel frame, middle image line light-transmitting plate



NB-C15

发纹不锈钢框架, 亚克力, LED 筒灯
Hairline stainless steel frame, acrylic, LED downlight



NB-C16

不锈钢框架, 亚克力, LED 筒灯
Stainless steel frame, acrylic, LED downlight



NB-C17

不锈钢框架, 亚克力透光板
Stainless steel frame, acrylic



NB-C18

钛金不锈钢框架, 亚克力灯饰板, 筒灯
Ti-plated stainless steel frame with acrylic top panel, downlights

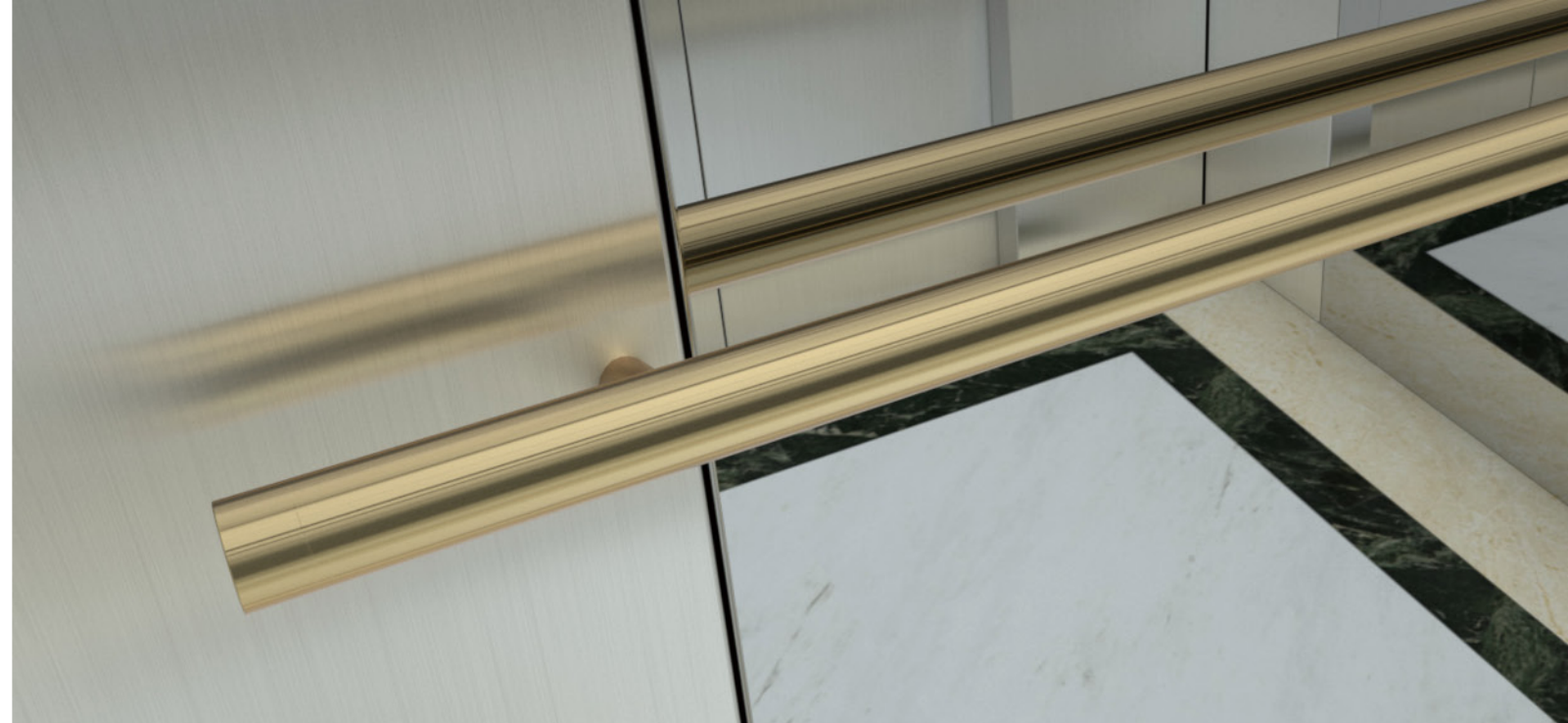

扶手系列 (选配)

Handrail series (optional)



NB-H01 不锈钢单管
Stainless steel single pipe



NB-H02 不锈钢双管
Stainless steel double pipe



NB-H03 不锈钢扁扶手
Stainless steel flat armrest



NB-H04 钛金不锈钢单管
Titanium gold stainless steel single pipe



NB-H05 钛金不锈钢双管
Titanium gold stainless steel double pipe



NB-H06 实木、钛金不锈钢
Solid wood, titanium stainless steel



NB-H07 不锈钢圆管造型扶手
Stainless steel tube model handrail

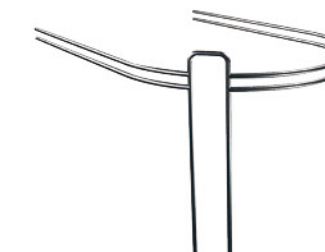

NB-H08 不锈钢圆管造型扶手
Stainless steel tube model handrail



NB-H09 不锈钢圆管造型扶手
Stainless steel tube model handrail

图片系电脑绘制, 可能与实物略有不同。
The picture is drawn by computer, which may be slightly different from the final product.

图片系电脑绘制, 可能与实物略有不同。
The picture is drawn by computer, which may be slightly different from the final product.

OPTIONAL DECORATION

可选装潢

厅门系列 (选配)

Landing door series (optional)



NB-D02

镜面、蚀刻
Mirror, etching



NB-D03

发纹不锈钢、蚀刻
Hairline stainless steel, etching



NB-D04

发纹不锈钢、玻璃
Hairline stainless steel, glass



NB-D05

钛金、镜面、蚀刻、和纹
Titanium, mirror, etching, vibration finish



NB-D06

黑钛镜面不锈钢，蚀刻
Black titanium mirror stainless steel, etching



NB-D07

玫瑰金发纹不锈钢，蚀刻
Rose gold hairline stainless steel, etching



NB-D08

发纹不锈钢、蚀刻
Hairline stainless steel, etching



NB-D09

钛金镜面不锈钢、蚀刻
Titanium mirror stainless steel, etching

地板系列 (PVC)

Floor series (PVC)

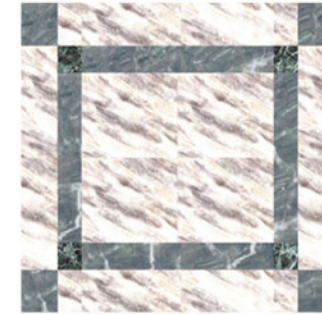

NB-F02

标配 Standard



NB-F03

选配 Optional



NB-F04

选配 Optional



NB-F05

选配 Optional

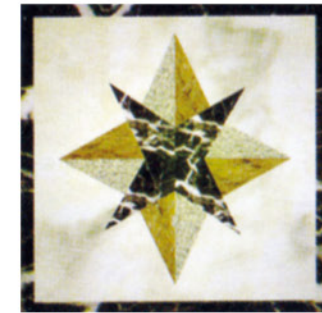

NB-F06

选配 Optional



NB-F07

选配 Optional

到站灯 (PVC)

Landing direction indicator (optional)



NB-L01



NB-L02



NB-L03



NB-L04



NB-L05

色卡系列

Colors series

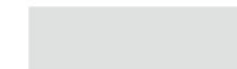

NB-S01

浅灰 Light gray



NB-S02

米色 Cream-colored



NB-S03

蓝色 Blue



NB-S04

苹果绿 Apple green



NB-S05

电脑灰 Computer gray

图片系电脑绘制，可能与实物略有不同。
The picture is drawn by computer, which may be slightly different from the final product.

图片系电脑绘制，可能与实物略有不同。
The picture is drawn by computer, which may be slightly different from the final product.

FUNCTION TABLE

电梯功能表

| 标准功能 Standard Function | |
|--|---|
| 全集选控制 All selective control | 电梯在运行过程中，在响应轿厢内指令信号的同时，自动响应上下召唤按钮信号，任何楼层的乘客都可以通过登记上下召唤信号召唤电梯。 When the elevator travels, at the same time of responding the car command signal, it automatically responds up/down calling signal. The passenger at any floor can call the elevator through registering up/down calling signal. |
| 开门保持功能 Door-opening function | 在操作盘上安装有开门保持按钮，动作后可延长开门时间。 If you press "door-opening button" in operation panel, it can prolong door-opening time. |
| 检修运行操作 Inspection running operation | 进入检修状态时，电梯以低速点动运行。 When entering inspection operation, the car comes into inching operation at low speed. |
| 直接停靠 Direct parking | 电梯完全按照距离原则减速，平层时无任何爬行。 When the elevator decelerates according to distance principle, it does not crawl at all in leveling. |
| 慢速自救运行 Slow self-rescue operation | 当电梯处于非检修状态下，且未停在平层区。此时只要符合自动的安全要求，电梯将自动以慢速运行至平层区，开门放人。 When the elevator is under non-inspection condition and it does not park at leveling zone, it slowly and automatically runs to leveling zone, opens the door and releases the passengers. |
| 紧急救援运行 Emergency rescue running | 设置紧急电动运行开关，以替代手动盘车装置。 It sets "emergency electric running switch" to replace for manual jigger. |
| 锁梯服务 Locking service | 在基站召唤盒上安装有锁梯开关，开关动作后，电梯只响应轿厢内指令。之后运行至基站开门后 10 秒左右关门停梯。 Locking switch is installed in home landing calling box. After the switch acts, it only responds the car command. It then runs to home landing, opens the door for about 10 second, shuts the door and stops. |
| 自返基站 Automatic return to home landing | 电梯在一段时间内无运行指令时，会自动返回基站待梯。 If the elevator does not have running command for certain period of time, it automatically returns to home landing and waits for the calling. |
| 待梯时轿内照明、风扇自动断电 Automatic cut-off of fan, lighting in the car in waiting condition | 如电梯无指令和外召登记超过 5 分钟，轿厢内照明、风扇自动断电。但在接到指令或召唤信号后，又会自动上电投入使用。 If the elevator has no command/ calling register for over 5 minutes, it automatically cuts off fan, lighting in the car. At receiving the command/ calling signal, it starts again. |
| 服务楼层设置 Setting of service floor | 系统可根据需要灵活选择关闭或激活某个或多个电梯服务楼层及停站楼层。 The system can flexibly shuts/ activates certain/ multiple elevator service floor(s), parking floor(s) according to actual requirements. |
| 楼层位置信号的自动修正 Automatic correction of floor position signal | 系统运行时，在每个终端开启动作点和每层楼平层开启动作点都对电梯的位置信号以自学习时得到的位置数据进行修正。 When the system runs, it will correct the position data in each terminal switch action-point and leveling switch action-point at each floor through self-tuning. |
| 点阵式楼层显示器 Dot-matrix floor display | 在轿厢内、轿厢外都安装有阵显示器，即时显示电梯运行状态。 Dot matrix display is available inside/ outside the car to instantly show the elevator running condition. |
| 特殊楼层显示 Special floor display | 可任意设定楼层显示字符，方便现场特殊要求。 It can freely set "floor display characters". It is convenient for special requirements at site. |
| 反向自动消号 Automatic cancel in reversal operation | 当电梯运行到终端层站或者运行方向改变时，将此前所登记的反向指令全部自动取消。 When the elevator runs to terminal landing or it changes the running direction, it will then cancel all the previously-registered reversal commands. |
| 开关门故障保护 Protection to door opening/ closing trouble | 当检测到开关门超过设定次数后仍未有效关门，系统停止开关门并输出故障。 When door opening/ closing times exceed set times, it still can not open/ close effectively, the system stops its operation and outputs the trouble. |
| 上行超速保护 Up-motion over-speed protection | 电梯上行速度超过设定值时，夹绳器动作，使电梯停止运行。 When up speed of the elevator exceeds set value, rope gripper acts to stop the operation. |
| 下行超速保护 Down-motion over-speed protection | 电梯下行速度超过设定值时，限速器、安全钳会动作，使电梯停止运行。 When down speed of the elevator exceeds set value, speed limiter and safety tongs act to stop the operation. |
| 开门按钮开门 Door opening button | 电梯停在门区时，可以在轿厢中按开门按钮使电梯已经关门或尚未关闭的门重新打开。 When the elevator stops at door zone, press "door opening button" in the car so that the closed/closing door opens again. |
| 关门按钮提前关门 Door closing button to shut the door in advance | 在保持开门的状态时，可以按关门按钮使门立即响应关门动作，提前关门。 When the door opens, press "door closing button" can let the door immediately respond door-closing action and shut the door in advance. |
| 重复开门 Repeated door opening | 如果电梯持续关门 15 秒后，尚未使门锁闭合，电梯就会转换成开门状态。 If the elevator repeatedly closes for 15 second, and it still does not close effectively, it will then turn to opening condition. |
| 满载直驶 Full-load by-pass | 当轿厢满载时，电梯不响应经过的召唤信号而只响应指令信号。 When the car is full of load, the elevator will not respond any passed calling signals, it only responds the command signal. |
| 超载保护 Overload protection | 电梯载重超过设定值时，电梯鸣叫提示超载，开门不运行。 When the elevator load exceeds set value, the elevator rings to remind of overload. It opens the door and does not operate. |

标准功能 Standard Function

| | |
|--|--|
| 火灾紧急返回运转 Emergency return operation at fire disaster | 火灾开关动作后，电梯直驶至消防阶，开门放人后停梯。 After "fire switch" acts, the elevator straightly travels to fire step, after it opens the door and releases the passengers, it then stops the operation. |
| 独立运行 Independent running | 通过动作开关，使电梯不响应外召，仅响应轿内指令。 Through action switch, the elevator no longer responds any outer calling. It only responds the car command. |
| 逆向运行保护 Reversal running protection | 电梯实际运行的方向与指令方向不一致时，就会立即紧急停车，故障报警。 When the actual elevator running direction does not coincide with the command direction, it immediately makes emergency stop and alarms the trouble. |
| 防打滑保护 Anti-skid protection | 电梯连续运行了限制器规定的时间，而平层开关没有动作，就停止轿厢一切运行。 When the continuous elevator operation exceeds the time stipulated by the limiter and leveling switch does not act, it then stops all the car running. |
| 故障自诊断 Trouble self-diagnosis | 控制器可以记录最新的 6 个故障，以便迅速排除故障，恢复电梯运行。 The controller can record 6 latest troubles so as to rapidly remove the trouble and restore the elevator running. |
| 警铃 Alarm bell | 紧急时，按下轿厢内的警铃按钮，电梯轿顶上的警铃会鸣响。 In emergency case, press "alarm bell button" in the car, it rings the alarm bell on top of the elevator car. |
| 应急照明 Emergency lighting | 停电时，自动点亮轿厢内的应急照明灯。 In power failure, it automatically brightens emergency lamp in the car. |
| 五方通话装置 Five-party conversation device | 通过对讲机，可以让轿厢、轿顶、机房、底坑、值班室之间相互通话。 Through intercom, people can talk amid the car, car-top, machine room, pit and duty-room. |
| 门光幕保护 Door light-curtain protection | 当两扇门的中间有东西阻挡时，门区光幕装置会动作，使电梯开门。 When something hinders in the middle of 2 door leaves, light-curtain device in door zone acts to open the door. |
| 防终端越程保护 Anti terminal over-travel protection | 电梯的上下终端都装有终端减速开关和终端极限开关，以保证电梯不会超越行程。 Up/ down terminal of the elevator installs terminal deceleration switch and terminal limit switch to ensure that it does not over-travel. |
| 减速开关故障保护 Protection against deceleration switch trouble | 在减速开关失效的状态下，电梯紧急停靠，防止冲顶或蹲底。 When deceleration switch is ineffective, the elevator makes emergency parking to prevent it from rushing to top/ bottom. |
| 安全回路故障保护 Protection against safety loop trouble | 系统收到安全回路故障信号就紧急停车，并在有故障时防止电梯运行。 When the system receives safety loop trouble signal, it makes emergency stop. Under the troubled condition, it prevents from the elevator running. |
| 轿厢防意外移动 Elevator cab prevents accidental movement | 电梯再开门状态下，轿厢出现意外移动时，使轿厢停止移动。 When the elevator is in the open state, if there is accidental movement, the elevator cab can present the movement. |

选配功能 Optional Function

| | |
|--|--|
| 开门再平层 Door-opening re-leveling | 电梯门开启状态，由于重量等原因导致电梯平层不准时，会自动校正平层。 When the elevator door opens, if it makes inaccurate leveling due to weight etc., it will then automatically correct the leveling. |
| 消防员操作 Fireman operation | 消防员开关动作时，电梯运行至基站开门放人后，专供消防员操作。 When fireman switch acts, after the elevator runs to home landing; opens the door and releases the passengers, it is then for special use of firemen. |
| 副操作盘操作 Operation of secondary operation panel | 在有主操作盘的同时，可以选配安装副操作盘，方便乘客使用。 At the same time of having main operation panel, it can choose optional secondary operation panel. It is convenient for the use of the passengers. |
| 前后门操作 Front-and-rear door operation | 电梯可同时具备前后门，并能分别控制，安全方便。 The elevator can simultaneously have front and rear doors for repective control. It is safe and convenient. |
| 联动运行 Linkage operation | 两台电梯共用外召信号，自动调度召唤响应，提高运行效率。 When two elevators share outer calling signal, it automatically dispatches the calling response. It thus increases the running efficiency. |
| 群控运行 Group-supervision running | 多台电梯（3-8 台）共用外召信号，自动调度召唤响应，提高运行效率。 When multiple elevators (three to eight elevators) share outer calling signal, it automatically dispatches the calling response. It thus increases the running efficiency. |
| 称重信号补偿 Counterweight signal compensation | 系统可以在高端应用场合中使用称重信号，对电梯的启动进行补偿。 The system can pre-output the torque which matches with the corresponding load to ensure the comfortable elevator travel. |
| 预转矩设置 Pre-torque setting | 系统可预先输出与相应的负载匹配的转矩，以保证电梯的舒适感。 In automatic condition, the door keeps open without any command. And the lift immediately shuts the door and responds to the command if any. |
| 司机操作运行 Driver's operation | 电梯轿厢内安装司机控制开关动作后，只能供轿厢内司机操作使用。 When the elevator car installs driver's control switch, after it acts, it can only be used for the driver's operation in the elevator car. |
| 轿厢摄像功能 Car camera functions | 在轿厢内安装摄像头，可监视轿厢内状况。 The car installs camera to monitor the car conditions. |

CONSTRUCTION PARAMETERS

小机房乘客电梯 / 土建参数

无机房乘客电梯 / 土建参数

井道立面图

Hoistway elevation

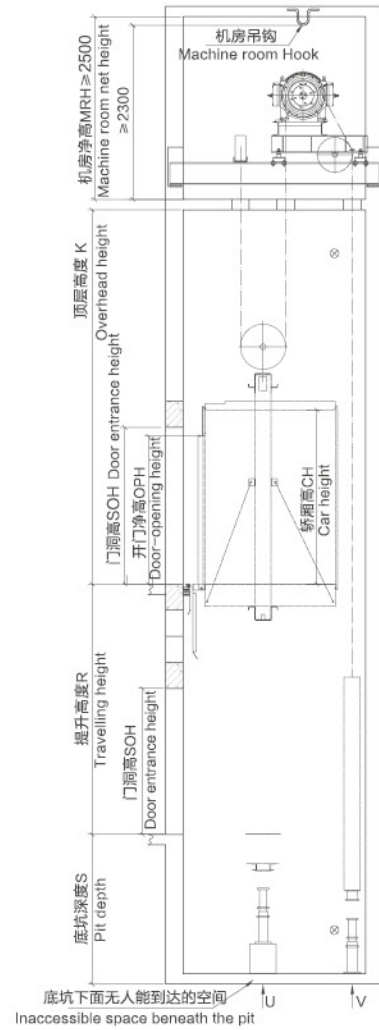

机房平面布置图

Machine room plan

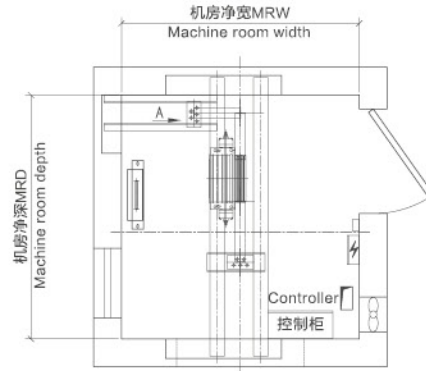

井道平面布置图

Hoistway plan

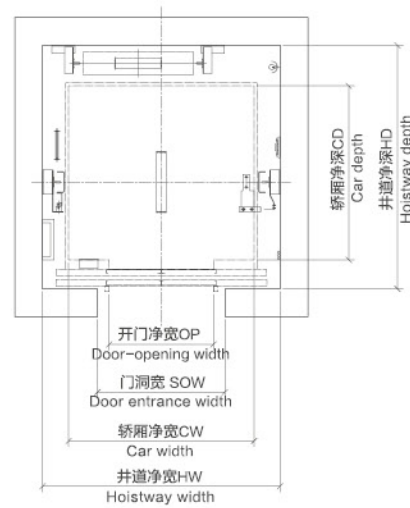

井道立面图

Hoistway elevation

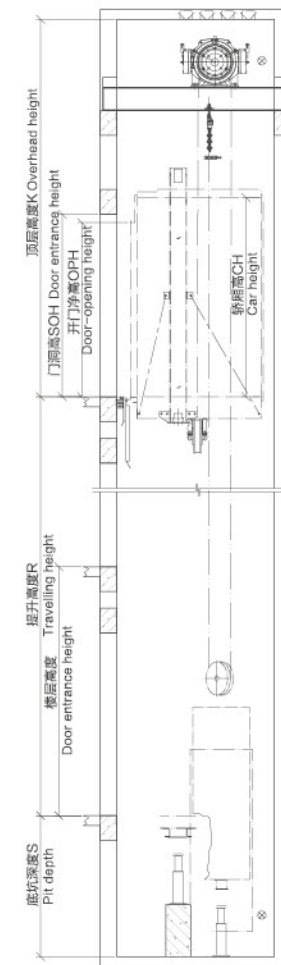

顶层平面图

Overhead floor plan

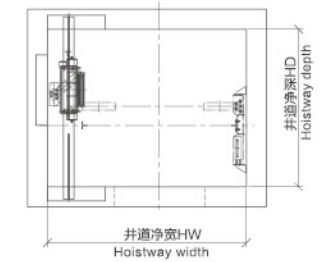

井道平面布置图

Hoistway plan

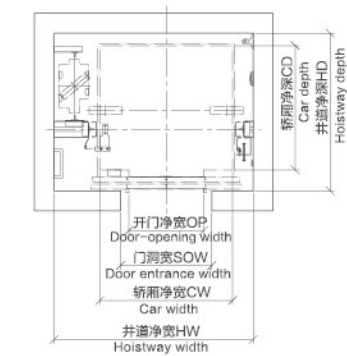

| 载重量 (kg) Load | 速度 (m/s) Speed | 轿厢净尺寸 (mm) Net dimension of car | | | | | 井道净尺寸 (mm) Net dimension of hoistway | | | | | 机房净尺寸 (mm) Net dimension of machine room | | | 最大层站 (层) Maximum floor | 最大行程 (m) Maximum travelling | | |
|------------------|-------------------|------------------------------------|------------|-------------|------------------------|-------------------------|---|------------|-------------------|--------------------|-----------|---|------------|------------|---------------------------|--------------------------------|-------------|------|
| | | 宽 width | 深 Depth | 高 Height | 开门宽 Door open width | 开门高 Door open height | 宽 width | 深 Depth | 门洞宽 Gate width | 门洞高 Gate height | 底坑 Pit | 顶层 Overhead | 宽 width | 深 Depth | | | 高 Height | |
| 450 | 1.0 | 1100 | 1100 | 2500 | 700 | 1600 | 1500 | 900 | 2200 | 1500 | 4300 | 1600 | 1500 | 2500 | 15 | 45 | | |
| | 1.0 | | | | | | | | | | | | | | | | 1500 | 4350 |
| 630 | 1.5 | 1400 | 1100 | 2500 | 800 | 1850 | 1700 | 1000 | 2200 | 1600 | 4500 | 1850 | 1700 | 2500 | 24 | 72 | | |
| | 1.75 | | | | | | | | | | | | | | | | 1600 | 4550 |
| | 1.0 | | | | | | | | | | | | | | | | 1500 | 4350 |
| 800 | 1.5 | 1400 | 1350 | 2500 | 800 | 1850 | 1950 | 1000 | 2200 | 1600 | 4500 | 1850 | 1950 | 2500 | 24 | 72 | | |
| | 1.75 | | | | | | | | | | | | | | | | 1600 | 4550 |
| | 1.0 | | | | | | | | | | | | | | | | 1500 | 4350 |
| 1000 | 1.5 | 1600 | 1500 | 2500 | 900 | 2050 | 2100 | 1100 | 2200 | 1600 | 4500 | 2050 | 2100 | 2500 | 24 | 72 | | |
| | 1.75 | | | | | | | | | | | | | | | | 1600 | 4550 |
| | 1.0 | | | | | | | | | | | | | | | | 1500 | 4350 |
| 1150 | 1.5 | 2000 | 1350 | 2500 | 1100 | 2500 | 2100 | 1300 | 2200 | 1600 | 4650 | 2500 | 2100 | 2500 | 24 | 72 | | |
| | 1.75 | | | | | | | | | | | | | | | | 1650 | 4700 |
| | 1.0 | | | | | | | | | | | | | | | | 1550 | 4500 |
| 1350 | 1.5 | 2000 | 1500 | 2500 | 1100 | 2500 | 2200 | 1300 | 2200 | 1600 | 4650 | 2500 | 2200 | 2500 | 24 | 72 | | |
| | 1.75 | | | | | | | | | | | | | | | | 1650 | 4700 |
| | 1.0 | | | | | | | | | | | | | | | | 1550 | 4500 |
| 1600 | 1.5 | 2000 | 1700 | 2500 | 1100 | 2500 | 2400 | 1300 | 2200 | 1600 | 4650 | 2500 | 2400 | 2500 | 24 | 72 | | |
| | 1.75 | | | | | | | | | | | | | | | | 1650 | 4700 |
| | 1.0 | | | | | | | | | | | | | | | | 1550 | 4500 |

注：上述尺寸仅供参考，具体尺寸以合同签约时提供的土建图为准。 Note: Only for reference, final manufacture please follow contract.

| 载重量 (kg) Load | 速度 (m/s) Speed | 轿厢净尺寸 (mm) Net dimension of car | | | | | 井道净尺寸 (mm) Net dimension of hoistway | | | | | 最大层站 (层) Maximum floor | 最大行程 (m) Maximum travelling |
|------------------|-------------------|------------------------------------|------------|-------------|------------------------|-------------------------|---|------------|-----------|----------------|----|---------------------------|--------------------------------|
| | | 宽 width | 深 Depth | 高 Height | 开门宽 Door open width | 开门高 Door open height | 宽 width | 深 Depth | 底坑 Pit | 顶层 Overhead | | | |
| 450 | 1.0 | 1100 | 1100 | 2500 | 700 | 1900 | 1700 | 1500 | 4300 | 20 | 60 | | |
| | 1.0 | | | | | | | | | | | 1500 | 4300 |
| 630 | 1.5 | 1100 | 1400 | 2500 | 800 | 2000 | 1800 | 1600 | 4500 | 30 | 80 | | |
| | 1.75 | | | | | | | | | | | 1700 | 4600 |
| | 1.0 | | | | | | | | | | | 1500 | 4300 |
| 800 | 1.5 | 1400 | 1350 | 2500 | 900 | 2200 | 1750 | 1600 | 4500 | 30 | 80 | | |
| | 1.75 | | | | | | | | | | | 1700 | 4600 |
| | 1.0 | | | | | | | | | | | 1500 | 4300 |
| 1000 | 1.5 | 1600 | 1500 | 2500 | 900 | 2400 | 1900 | 1600 | 4500 | 30 | 80 | | |
| | 1.75 | | | | | | | | | | | 1700 | 4600 |
| | 1.0 | | | | | | | | | | | 1500 | 4300 |
| 1150 | 1.5 | 1600 | 1700 | 2500 | 1000 | 2650 | 2200 | 1600 | 4500 | 30 | 80 | | |
| | 1.75 | | | | | | | | | | | 1650 | 4600 |
| | 1.0 | | | | | | | | | | | 1600 | 4450 |
| 1350 | 1.5 | 1700 | 1800 | 2500 | 1100 | 2750 | 2250 | 1600 | 4550 | 30 | 90 | | |
| | 1.75 | | | | | | | | | | | 1650 | 4600 |
| | 1.0 | | | | | | | | | | | 1600 | 4450 |
| 1600 | 1.5 | 1700 | 2000 | 2500 | 1100 | 2750 | 2400 | 1600 | 4550 | 30 | 90 | | |
| | 1.75 | | | | | | | | | | | 1650 | 4600 |
| | 1.0 | | | | | | | | | | | 1600 | 4450 |
| 2000 | 1.5 | 1900 | 2000 | 2500 | 1100 | 2750 | 2400 | 1600 | 4550 | 30 | 90 | | |
| | 1.75 | | | | | | | | | | | 1650 | 4600 |
| | 1.0 | | | | | | | | | | | 1600 | 4450 |

注：上述尺寸仅供参考，具体尺寸以合同签约时提供的土建图为准。 Note: Only for reference, final manufacture please follow contract.

CONSTRUCTION PARAMETERS

高速电梯 / 土建参数

井道立面图

Hoistway elevation

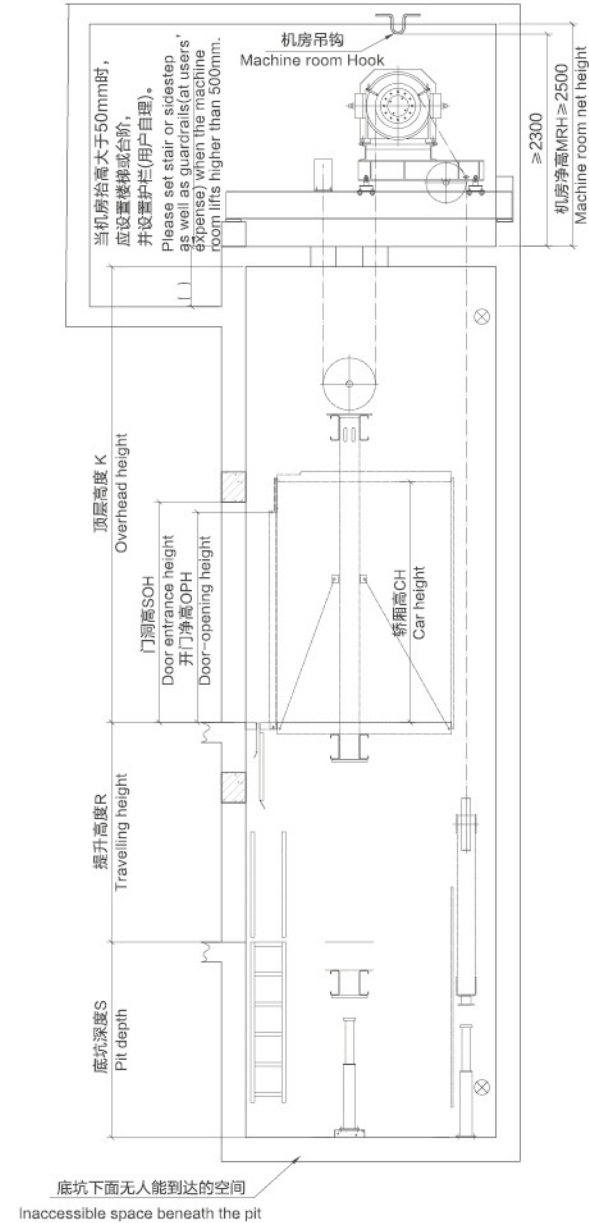

机房平面布置图

Machine room plan

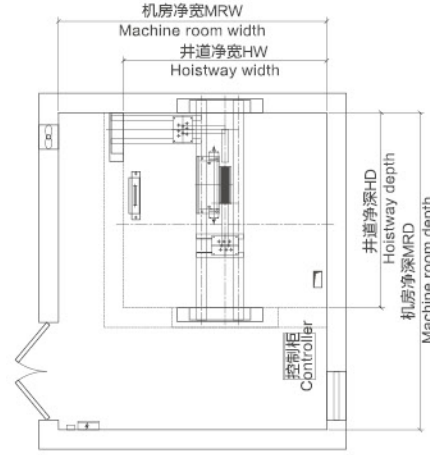

井道平面布置图

Hoistway plan

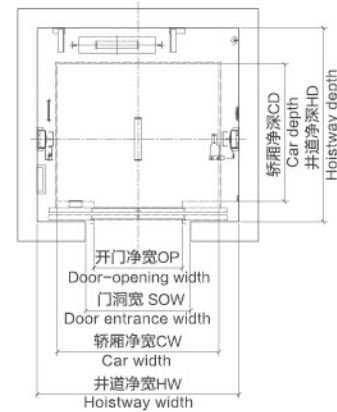

医用电梯 / 土建参数

井道立面图

Hoistway elevation

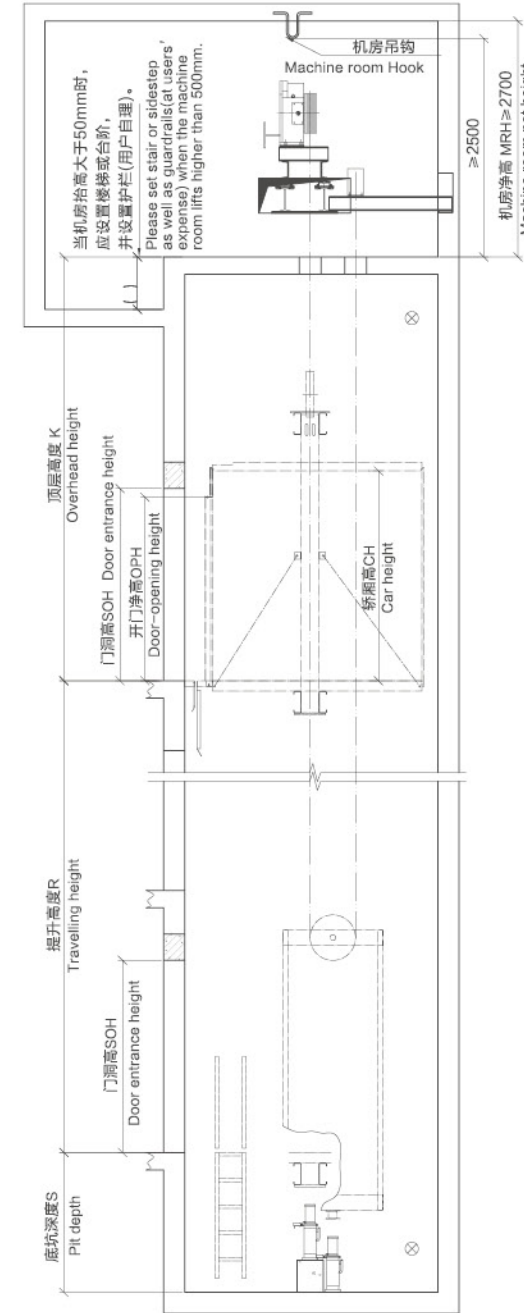

机房平面图

Machine room plan

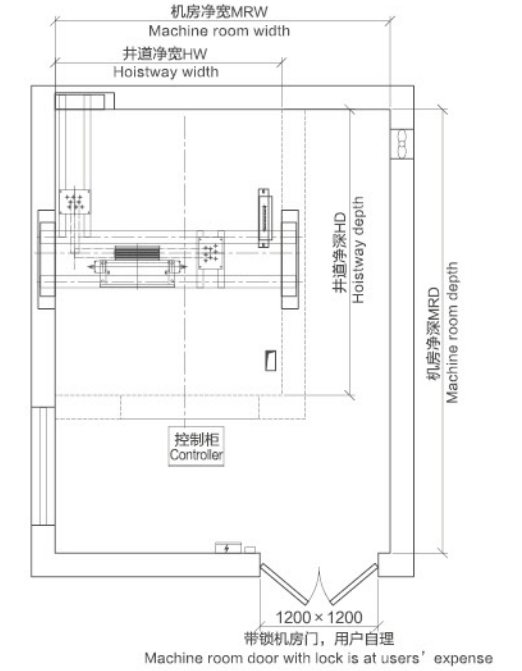

井道平面布置图

Hoistway plan

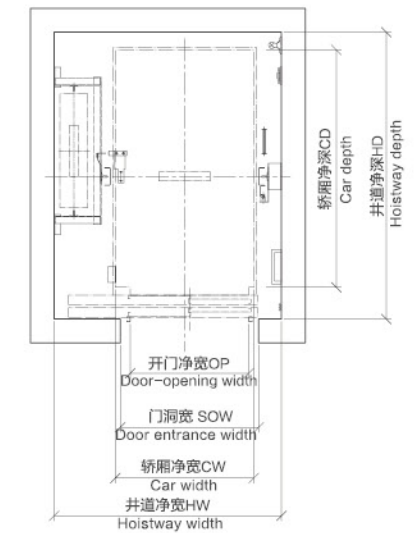

| 载重量 (kg) Load | 速度 (m/s) Speed | 轿厢净尺寸 (mm) Net dimension of car | | | | | 井道净尺寸 (mm) Net dimension of hoistway | | | | | 机房净尺寸 (mm) Net dimension of machine room | | | 最大层站 (层) Maximum floor | 最大行程 (m) Maximum travelling |
|---------------|----------------|---------------------------------|---------|----------|---------------------|----------------------|--------------------------------------|---------|----------------|-----------------|--------|--|---------|---------|------------------------|-----------------------------|
| | | 宽 width | 深 Depth | 高 Height | 开门宽 Door open width | 开门高 Door open height | 宽 width | 深 Depth | 门洞宽 Gate width | 门洞高 Gate height | 底坑 Pit | 顶层 Overhead | 宽 width | 深 Depth | | |
| 800 | 2.0 | 1400 | 1350 | 2500 | 800 | 1900 | 2000 | 1000 | 2200 | 1750 | 4700 | 3000 | 3500 | 2500 | 40 | 120 |
| | 2.5 | | | | | | | | | | | | | | | |
| 1000 | 2.0 | 1600 | 1500 | 2500 | 900 | 2100 | 2200 | 1100 | 2200 | 1750 | 4700 | 3100 | 3700 | 2500 | 40 | 120 |
| | 2.5 | | | | | | | | | | | | | | | |
| 1150 | 2.0 | 2000 | 1350 | 2500 | 1100 | 2500 | 2100 | 1300 | 2200 | 1750 | 4700 | 3300 | 3600 | 2500 | 40 | 120 |
| | 2.5 | | | | | | | | | | | | | | | |
| 1350 | 2.0 | 2000 | 1500 | 2500 | 1100 | 2500 | 2200 | 1300 | 2200 | 1750 | 4700 | 3300 | 3700 | 2500 | 40 | 120 |
| | 2.5 | | | | | | | | | | | | | | | |
| 1650 | 2.0 | 2000 | 1700 | 2500 | 1100 | 2500 | 2400 | 1300 | 2200 | 1750 | 4700 | 3300 | 3900 | 2500 | 40 | 120 |
| | 2.5 | | | | | | | | | | | | | | | |
| 2000 | 2.0 | 2000 | 2000 | 2500 | 1100 | 2500 | 2700 | 1300 | 2200 | 1750 | 4700 | 3300 | 4000 | 2500 | 40 | 120 |
| | 2.5 | | | | | | | | | | | | | | | |

注：上述尺寸仅供参考，具体尺寸以合同签约时提供的土建图为准。 Note: Only for reference, final manufacture please follow contract.

| 载重量 (kg) Load | 速度 (m/s) Speed | 轿厢净尺寸 (mm) Net dimension of car | | | | | 井道净尺寸 (mm) Net dimension of hoistway | | | | | 机房净尺寸 (mm) Net dimension of machine room | | | 最大层站 (层) Maximum floor | 最大行程 (m) Maximum travelling | | | | | |
|---------------|----------------|---------------------------------|---------|----------|---------------------|----------------------|--------------------------------------|---------|----------------|-----------------|--------|--|---------|---------|------------------------|-----------------------------|----------|------|------|----|-----|
| | | 宽 width | 深 Depth | 高 Height | 开门宽 Door open width | 开门高 Door open height | 宽 width | 深 Depth | 门洞宽 Gate width | 门洞高 Gate height | 底坑 Pit | 顶层 Overhead | 宽 width | 深 Depth | | | 高 Height | | | | |
| 1600 | 1.0 | 1400 | 2400 | 2500 | 1200 (旁开 Side) | 2100 | 2300 | 2900 | 1400 | 2200 | 1550 | 4500 | 3400 | 4500 | 2700 | 20 | 60 | | | | |
| | 1.5 | | | | | | | | | | | | | | | | | 1600 | 4650 | 24 | 72 |
| | 1.75 | | | | | | | | | | | | | | | | | 1650 | 4700 | 30 | 90 |
| | 2.0 | | | | | | | | | | | | | | | | | 1750 | 4800 | 40 | 120 |
| | 2.5 | | | | | | | | | | | | | | | | | 1950 | 4900 | 40 | 130 |

注：上述尺寸仅供参考，具体尺寸以合同签约时提供的土建图为准。 Note: Only for reference, final manufacture please follow contract.

CONSTRUCTION PARAMETERS

观光电梯 / 土建参数

井道立面图

Hoistway elevation

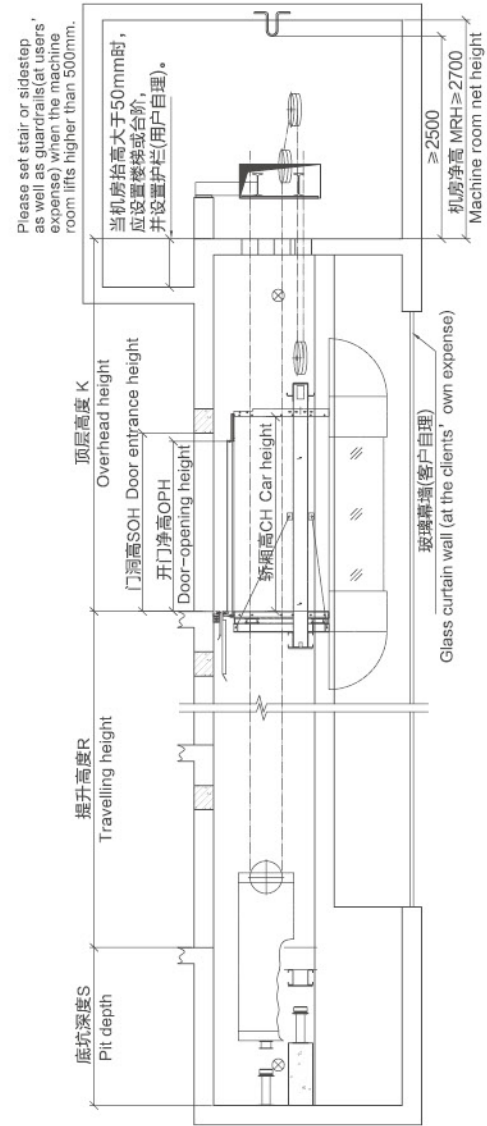

机房平面布置图

Machine room plan

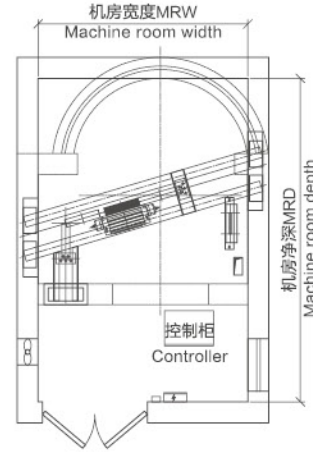

井道平面布置图

Hoistway plan

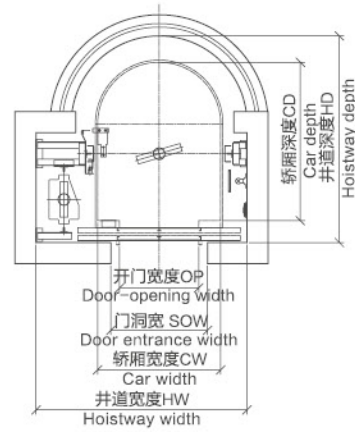

无机房观光电梯 / 土建参数

井道立面图

Hoistway elevation

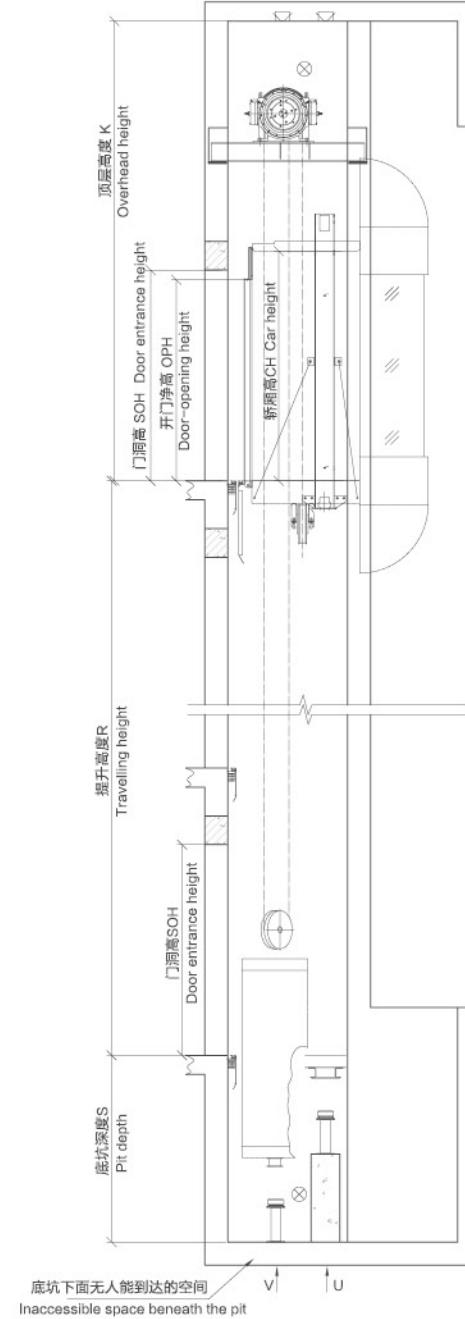

井道平面图

Hoistway plan

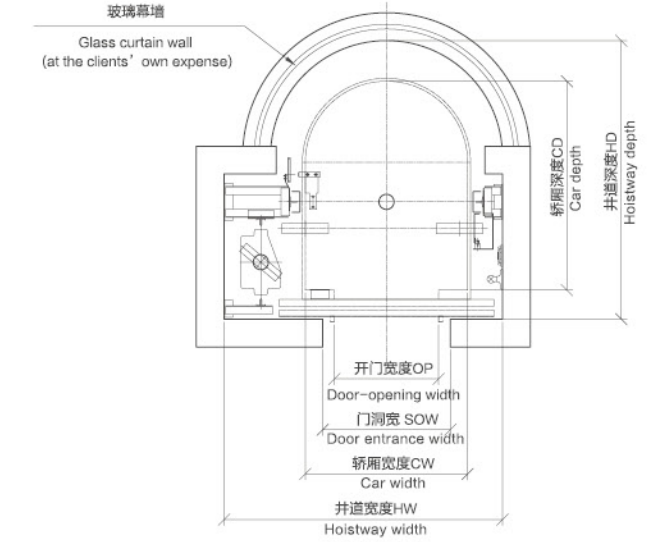

顶层平面图

Overhead plan

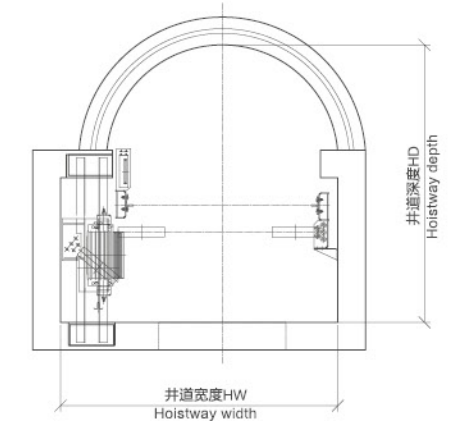

| 载重量 (kg) Load | 速度 (m/s) Speed | 轿厢净尺寸 (mm) Net dimension of car | | | | | 井道净尺寸 (mm) Net dimension of hoistway | | | | | 机房净尺寸 (mm) Net dimension of machine room | | | 最大层站 (层) Maximum floor | 最大行程 (m) Maximum travelling | | | |
|------------------|-------------------|------------------------------------|------------|-------------|------------------------|-------------------------|---|------------|-------------------|--------------------|-----------|---|------------|------------|---------------------------|--------------------------------|-------------|----|----|
| | | 宽 width | 深 Depth | 高 Height | 开门宽 Door open width | 开门高 Door open height | 宽 width | 深 Depth | 门洞宽 Gate width | 门洞高 Gate height | 底坑 Pit | 顶层 Overhead | 宽 width | 深 Depth | | | 高 Height | | |
| 800 | 1.0 | 1250 | 1700 | 2500 | 900 | 2100 | 2250 | 2250 | 1000 | 2200 | 1950 | 4400 | 2250 | 3600 | 2700 | 16 | 50 | | |
| | 1.5 | | | | | | | | | | | | | | | 2000 | 4550 | 25 | 80 |
| | 1.75 | | | | | | | | | | | | | | | 2050 | 4600 | 30 | 90 |
| 1000 | 1.0 | 1400 | 1800 | 2500 | 900 | 2100 | 2400 | 2350 | 1100 | 2200 | 1950 | 4400 | 2400 | 3700 | 2700 | 16 | 50 | | |
| | 1.5 | | | | | | | | | | | | | | | 2000 | 4550 | 25 | 80 |
| | 1.75 | | | | | | | | | | | | | | | 2050 | 4600 | 30 | 90 |
| 1150 | 1.0 | 1400 | 2000 | 2500 | 900 | 2100 | 2400 | 2550 | 1100 | 2200 | 1950 | 4400 | 2400 | 3900 | 2700 | 16 | 50 | | |
| | 1.5 | | | | | | | | | | | | | | | 2000 | 4550 | 25 | 80 |
| | 1.75 | | | | | | | | | | | | | | | 2050 | 4600 | 30 | 90 |
| 1350 | 1.0 | 1600 | 2000 | 2500 | 900 | 2100 | 2500 | 2550 | 1100 | 2200 | 1950 | 4400 | 2500 | 3900 | 2700 | 16 | 50 | | |
| | 1.5 | | | | | | | | | | | | | | | 2000 | 4550 | 25 | 80 |
| | 1.75 | | | | | | | | | | | | | | | 2050 | 4600 | 30 | 90 |
| 1600 | 1.0 | 1600 | 2250 | 2500 | 900 | 2100 | 2500 | 2800 | 1100 | 2200 | 1950 | 4400 | 2500 | 4000 | 2700 | 16 | 50 | | |
| | 1.5 | | | | | | | | | | | | | | | 2000 | 4550 | 25 | 80 |
| | 1.75 | | | | | | | | | | | | | | | 2050 | 4600 | 30 | 90 |

注: 上述尺寸仅供参考, 具体尺寸以合同签约时提供的土建图为准。 Note: Only for reference, final manufacture please follow contract.

| 载重量 (kg) Load | 速度 (m/s) Speed | 轿厢净尺寸 (mm) Net dimension of car | | | | | 井道净尺寸 (mm) Net dimension of hoistway | | | | | 最大层站 (层) Maximum floor | 最大行程 (m) Maximum travelling | | | |
|------------------|-------------------|------------------------------------|------------|-------------|------------------------|-------------------------|---|------------|-------------------|--------------------|-----------|---------------------------|--------------------------------|----------------|----|----|
| | | 宽 width | 深 Depth | 高 Height | 开门宽 Door open width | 开门高 Door open height | 宽 width | 深 Depth | 门洞宽 Gate width | 门洞高 Gate height | 底坑 Pit | | | 顶层 Overhead | | |
| 800 | 1.0 | 1250 | 1700 | 2500 | 900 | 2100 | 2250 | 2300 | 1000 | 2200 | 1950 | 4900 | 16 | 50 | | |
| | 1.5 | | | | | | | | | | | | 2000 | 5050 | 25 | 80 |
| | 1.75 | | | | | | | | | | | | 2050 | 5100 | 30 | 90 |
| 1000 | 1.0 | 1400 | 1800 | 2500 | 900 | 2100 | 2400 | 2400 | 1100 | 2200 | 1950 | 4900 | 16 | 50 | | |
| | 1.5 | | | | | | | | | | | | 2000 | 5050 | 25 | 80 |
| | 1.75 | | | | | | | | | | | | 2050 | 5100 | 30 | 90 |

注: 上述尺寸仅供参考, 具体尺寸以合同签约时提供的土建图为准。 Note: Only for reference, final manufacture please follow contract.

CONSTRUCTION PARAMETERS

家用电梯 / 土建参数

井道立面图
Hoistway elevation

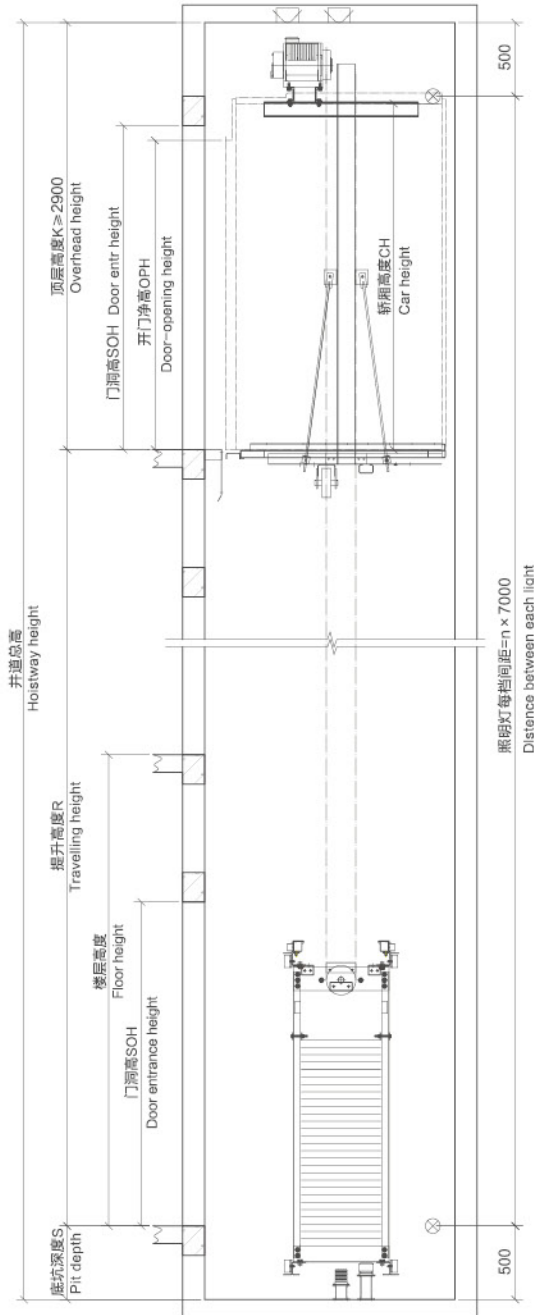

井道平面布置图
Hoistway plan

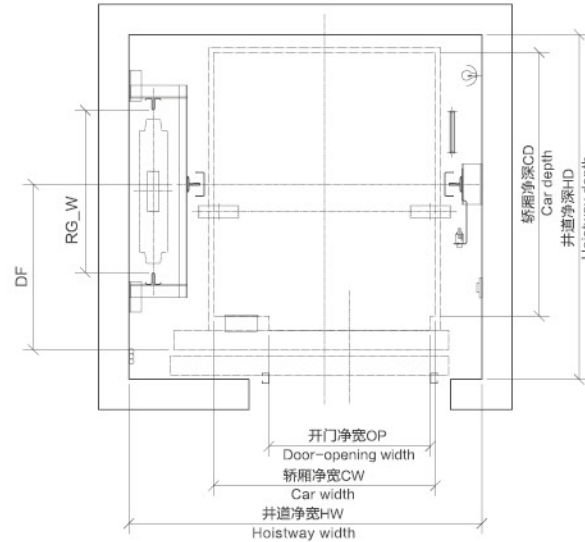

顶层井道平面图
Hoistway section of overhead

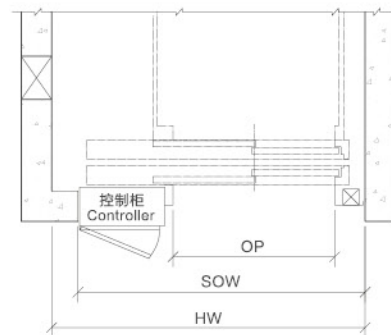

客户服务中心

我们构建了完整的服务体系，项目全生命周期内，都由专业人员负责沟通，认真聆听客户需求，进行全程提供最贴心的精细化服务，使用期间，定期对您的设备运行状态进行检测，确保设备始终处于最佳运行状态。

Customer Service Center

We have built a complete service system. During the entire life cycle of the project, professionals are responsible for communication, carefully listen to the customer needs, and provide the most intimate and refined services throughout the entire process. In use period, you will regularly check the operating status of your equipment to ensure the equipment is always in the best operating condition.

智能物联网平台

凭借智能物联网技术和公司自有的维保大数据，宁波御墅富士电梯自主研发智能物联网平台，为客户和乘客带来前所未有的智慧服务。

Intelligent IoT platform

Relying on the intelligent Internet of Things technology and the company's own maintenance big data, Ningbo Yushu Fuji Elevator independently develops an intelligent Internet of Things platform to bring unprecedented intelligent services to customers and passengers.



- 24/7 全天候实时联网监测
- 维保服务高度透明化
- 电梯故障快速应对
- 电梯预警干预机制

- 24/7 real-time online monitoring
- Highly transparent maintenance services
- Quick response to elevator failure
- Early warning and intervention mechanism of elevator

IIOT SERVICE PLATFORM·BUILDING OF DIGITAL EXPERIENCE

物联服务平台·构建数字体验

| 载重量 (kg) Load | 速度 (m/s) Speed | 轿厢净尺寸 (mm) Net dimension of car | | | | | 井道净尺寸 (mm) Net dimension of hoistway | | | | | 最大层站 (层) Maximum floor | 最大行程 (m) Maximum travelling | |
|---------------------|----------------------|------------------------------------|------------|-------------|------------------------|-------------------------|---|------------|-------------------|--------------------|-----------|------------------------------|-----------------------------------|----------------|
| | | 宽 width | 深 Depth | 高 Height | 开门宽 Door open width | 开门高 Door open height | 宽 width | 深 Depth | 门洞宽 Gate width | 门洞高 Gate height | 底坑 Pit | | | 顶层 Overhead |
| 225 | 0.4 | 900 | 1100 | 2300 | 800 (旁开) Side | 2100 | 1550 | 1500 | 1000 | 2200 | ≥ 500 | ≥ 2900 | 5 | 12 |
| 320 | 0.4 | 1000 | 1200 | | | | 1650 | 1600 | | | | | 5 | 12 |
| 400 | 0.4 | 1100 | 1300 | | | | 1750 | 1700 | | | | | 5 | 12 |

注：上述尺寸仅供参考，具体尺寸以合同约定时提供的土建图为准。 Note: Only for reference, final manufacture please follow contract.