

2022

<http://www.sigmaliftshanghai.com>

SHANGHAI SIGMA PRODUCT AGGREGATE



上海星玛电梯有限公司
SIGMA ELEVATOR SHANGHAI CO., LTD.

地址：苏州市吴江区同安西路92号
Add: No.92, Tongan West Road, Wujiang District,
Suzhou City, Jiangsu Province, China

电话(TEL) : +86 18917616151
E-mail : export@sigmaliftshanghai.com
<http://www.sigmaliftshanghai.com>

本印刷品仅供参考。本公司有权随时更改产品设计和规格。本印刷品所载信息就产品及其特殊用途之适用性、适用性、品质或任何采购协议条款不构成任何明示或暗示的担保或承诺。
The printed products are for reference only,the company has the right change the designs and specifications of the products at any time,the information contained in the printed products does not constitute any express or implied guarantees or commitment for the products and its applicability ,merchantability,and quality of special purposes,or any terms of procurement agreement.

上海星玛电梯有限公司 2022年07月印刷

SIGMA ELEVATOR SHANGHAI CO., LTD. Printed in July, 2022

英联嘉合 画册设计+印刷 13584251557

上海星玛电梯有限公司
SIGMA ELEVATOR SHANGHAI CO., LTD.

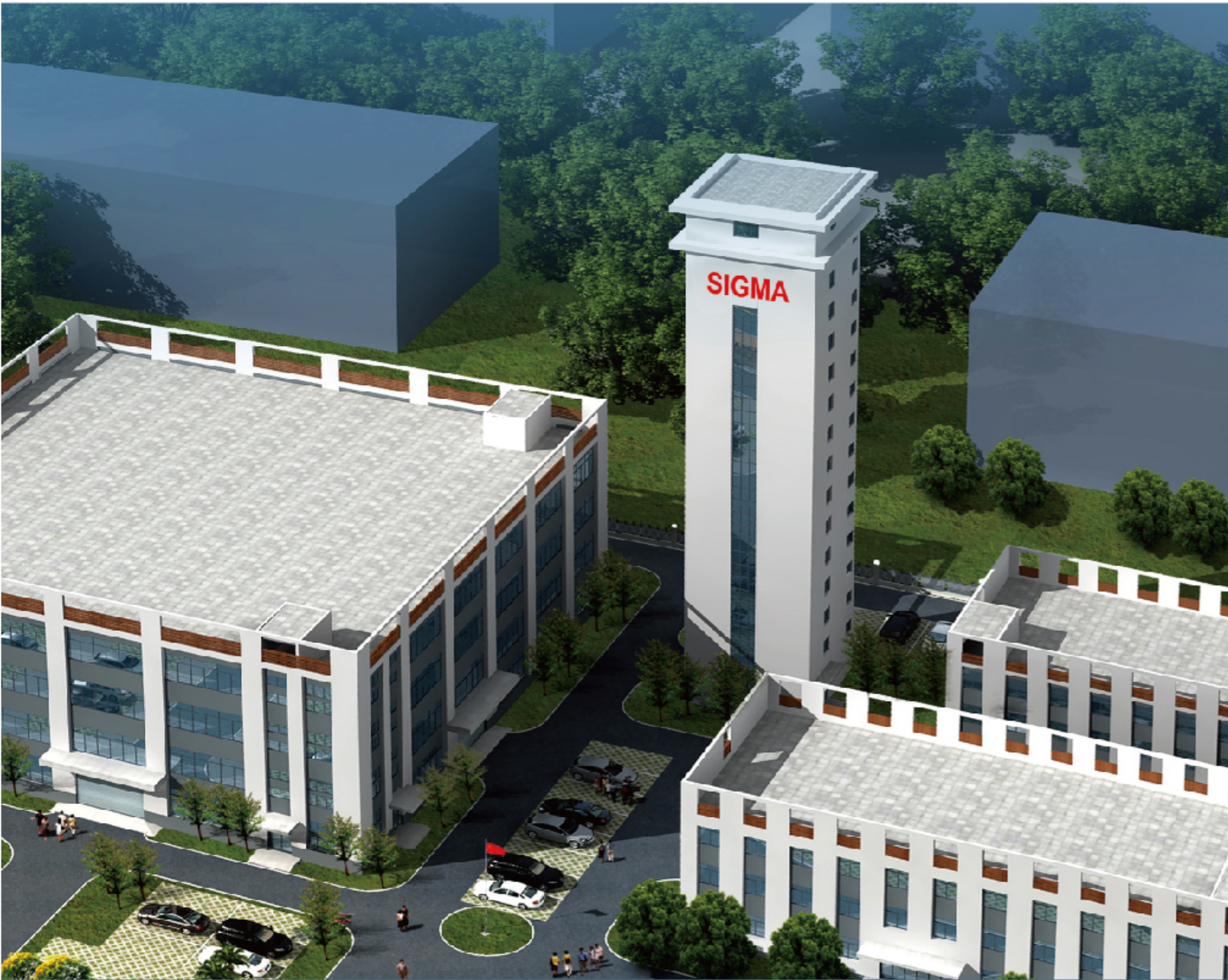

COMPANY PROFILE

企业简介

上海星玛电梯有限公司成立于2005年,坐落于上海市浦东新区康桥工业园区。
公司致力于电梯的生产制造,是国家特种设备制造和安装改造维修许可证双A资质持有企业。
公司生产客梯,货梯,担架梯,汽车梯,别墅梯,自动扶梯,自动人行道,购物梯全梯种。
公司已进入创新发展时期,产品科技和外观不断更新。

上海星玛电梯有限公司在占有一定规模国内市场的同时,不断开拓海外市场,现已销售到非洲,欧洲,南美洲,东南亚三十多个国家地区,承担了一些国外地标性工程。
我们秉承:‘尽心尽职,提供客户满意的产品,一流的服务’这一宗旨。产品质量从设计到制造,从安装到服务均严格受控,为客户提供高性价比的电梯产品,也反映了我们对自己所负社会责任的深深关切与郑重承诺。

SIGMA Elevator Shanghai Co., Ltd. was established in 2005 and is located in Kangqiao Industrial Park, Pudong New District, Shanghai. The company is committed to the production and manufacture of elevators and is a double-A qualification holding enterprise for the national special equipment manufacturing and installation, renovation and maintenance license. The company produces passenger elevators, freight elevators, stretcher elevators, car elevators, villa elevators, escalators, moving walks, shopping elevators. The company has entered a period of innovation and development, and product technology and appearance are constantly updated.

While occupying a certain scale of domestic market, SIGMA Elevator Shanghai Co., Ltd. continues to develop overseas markets. It has been sold to more than 30 countries and regions in Africa, Europe, South America, Southeast Asia, and has undertaken some foreign landmark projects. We are adhering to the tenet: ‘Dedicated to your duties, provide customers with satisfactory products and first-class service’ . Product quality is strictly controlled from design to manufacturing, from installation to service. Providing customers with cost-effective elevator products also reflects our deep concern and solemn commitment to our own social responsibility.

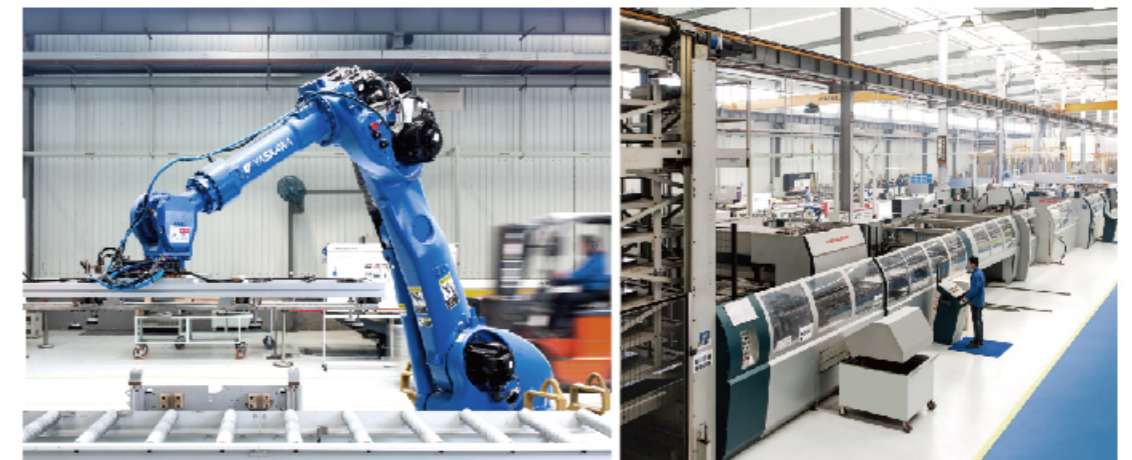



目录 CONTENTS
美好，从此刻开始...

01 / 简约型乘客轿厢 05
SIMPLIFIED PASSENGER CAR

02 / 复古型乘客电梯 17
RETRO PASSENGER CAR

03 / 奢华型乘客电梯 37
LUXURY PASSENGER CAR

04 / 温馨型家用轿厢 55
WARM FAMILY CAR

05 / 观光型乘客轿厢 67
OBSERVATION PASSENGER CAR

part 01

简约型乘客轿厢

SIMPLIFIED PASSENGER CAR



轿厢装潢
CAR DECORATION



SGM-P001



- Ceiling: Hairline Frame, Acrylic Light
- Car Wall: Stainless Steel Hairline
- Handrail: Option
- Floor: PVC / Marble

趋于简约，崇尚自然，将现代化的时尚文明融于轻盈的设计中，演绎卓尔不凡的生活品质。

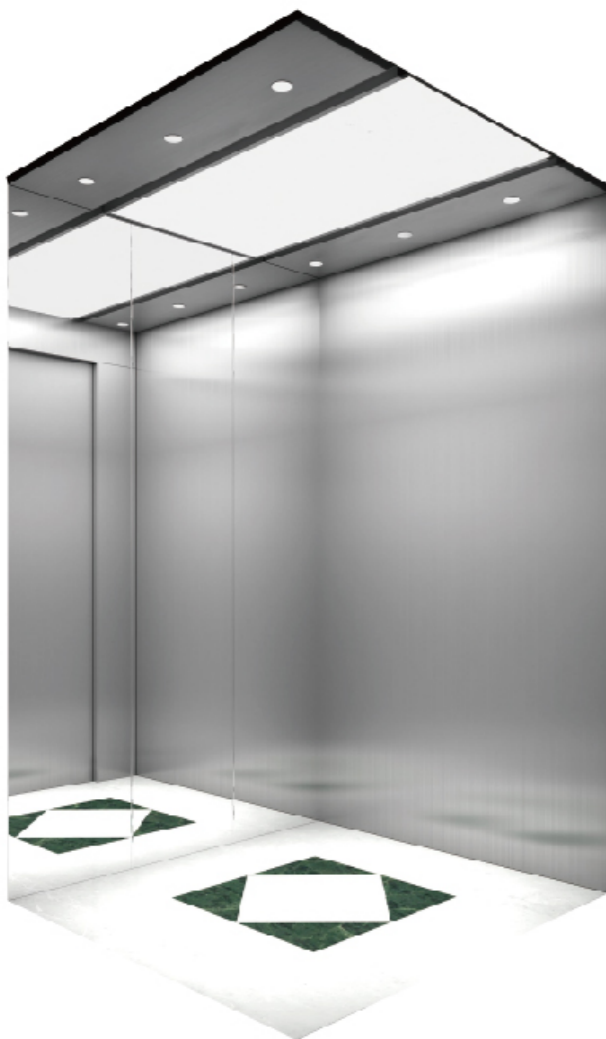

SGM-P002



Ceiling: Hairline Frame, Acrylic Light,
Downlight
Car Wall: Back Wall Mirror, Side Wall
Hairline
Handrail: Option
Floor: PVC / Marble



SGM-P003



Ceiling: Mirror, Acrylic Light,
Downlight
Car Wall: Mirror Etching
Handrail: Option
Floor: PVC / Marble



SGM-P004



Ceiling: Mirror, Acrylic Light
Car Wall: Mirror Etching
Handrail: Option
Floor: PVC / Marble



SGM-P005



Ceiling: Mirror Frame , Acrylic
Light, Downlight
Car Wall: Mirror Etching
Handrail: Option
Floor: PVC / Marble



SGM-P006



Ceiling: Mirror Frame , Acrylic Light
Car Wall: Mirror Etching
Handrail: Option
Floor: PVC / Marble



SGM-P007



Ceiling: Mirror Frame , Acrylic
Light, Downlight
Car Wall: Mirror Etching
Handrail: Option
Floor: PVC / Marble



SGM-P008



Ceiling: Mirror Frame , Acrylic Light, Downlight
Car Wall: Mirror Etching
Handrail: Option
Floor: PVC / Marble



SGM-P009



Ceiling: Mirror, Acrylic Light
Car Wall: Mirror Etching
Handrail: Option
Floor: PVC / Marble



SGM-P010



Ceiling: Hairline frame, Acrylic Light
Car Wall: Hairline, Mirror Etching
Handrail: Option
Floor: PVC / Marble



SGM-P011



Ceiling: Hairline frame, Acrylic Light
Car Wall: Hairline, Mirror Etching
Handrail: Option
Floor: PVC / Marble



SGM-P010



Ceiling: Mirror Frame , Acrylic
Light,Downlight
Car Wall: Mirror Etching
Handrail: Option
Floor:PVC / Marble



SGM-P012



Ceiling:Mirror, Acrylic Light
Car Wall: Mirror Etching
Handrail: Option
Floor: PVC / Marble

SGM-P011



Ceiling: Mirror Frame , Acrylic Light
Car Wall:Mirror Etching
Handrail: Option
Floor: PVC / Marble



SGM-P013



Ceiling:Mirror Frame , Acrylic
Light,Downlight
Car Wall: Mirror Etching
Handrail: Option
Floor:PVC / Marble





SGM-P014



Ceiling: Mirror Frame , Acrylic Light
Car Wall: Mirror Etching
Handrail: Option
Floor: PVC / Marble



SGM-P016



Ceiling: Mirror, Acrylic Light
Car Wall: Mirror Etching
Handrail: Option
Floor: PVC / Marble

SGM-P015



Ceiling: Mirror Frame , Acrylic Light
Car Wall: Mirror Etching
Handrail: Option
Floor: PVC / Marble



SGM-P017



Ceiling: Mirror, Acrylic Light
Car Wall: Mirror Etching
Handrail: Option
Floor: PVC / Marble





SGM-P018



Ceiling: Mirror, Acrylic Light
Car Wall: Mirror Etching
Handrail: Option
Floor: PVC / Marble

SGM-P020



Ceiling: Mirror Frame , Acrylic Light
Car Wall: Mirror Etching
Handrail: Option
Floor: PVC / Marble

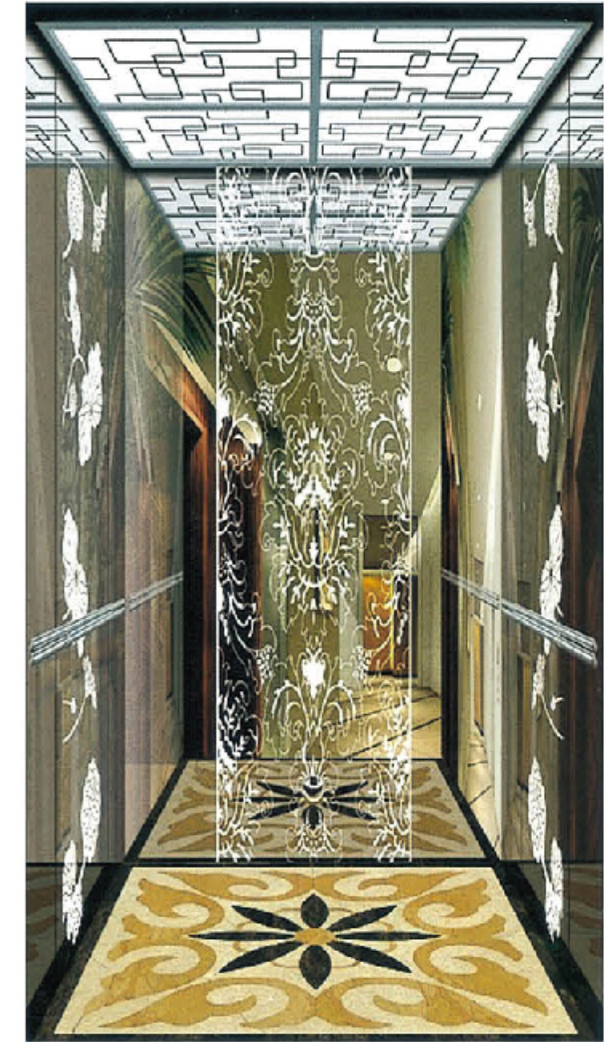

SGM-P019



Ceiling: Mirror Frame , Acrylic Light
Car Wall: Mirror Etching
Handrail: Option
Floor: PVC / Marble



SGM-P021



Ceiling: Mirror Frame , Acrylic Light
Car Wall: Mirror Etching
Handrail: Option
Floor: PVC / Marble

part
02

复古型乘客轿厢
RETRO PASSENGER CAR



SGM-P022



- Ceiling: Golden Mirror Frame ,
Downlights
- Car Wall: Golden Mirror Etching
- Handrail: Opition
- Floor: PVC / Marble

古朴庄重，做工考究，以独具匠心的设计创造电梯美学新高，信奉一份工匠精神，执着追求精品。



SGM-P023



Ceiling:Golden Mirror Frame , Acrylic
Light,Downlights
Car Wall: Golden Mirror Etching
Handrail: Option
Floor: PVC / Marble



SGM-P025



Ceiling:Golden Mirror Frame , Acrylic
Light,Downlights
Car Wall: Golden Mirror Etching
Handrail: Option
Floor: PVC / Marble

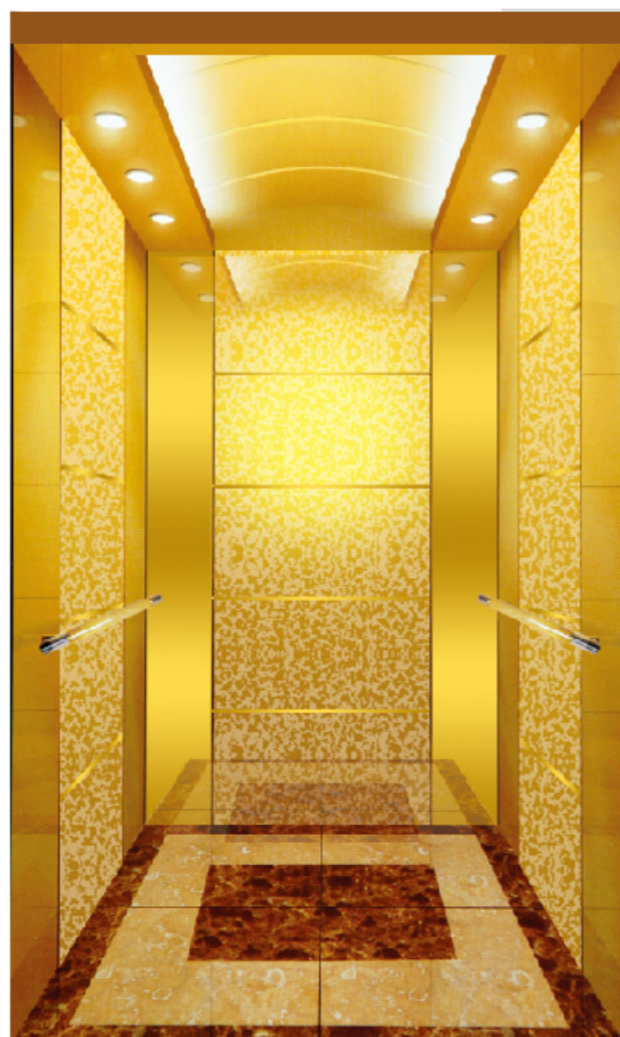

SGM-P024



Ceiling:Golden Mirror Frame,Light
Belt,Downlights
Car Wall: Golden Mirror Etching
Handrail:Option
Floor:PVC / Marble

SGM-P026



Ceiling: Golden Mirror Frame , Acrylic
Light
Car Wall: Golden Mirror Etching
Handrail: Option
Floor: PVC / Marble





SGM-P027



Ceiling: Golden Mirror Frame , Acrylic Light
Car Wall: Golden Mirror Etching
Handrail: Option
Floor: PVC / Marble

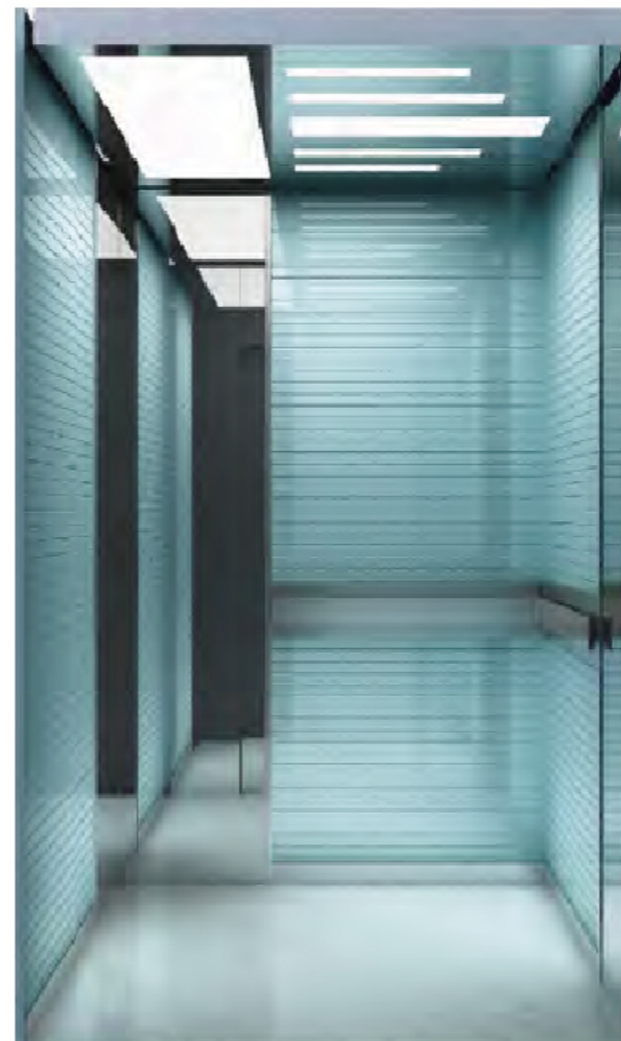

SGM-P029



Ceiling: Golden Mirror Frame , Acrylic Light
Car Wall: Golden Mirror Etching
Handrail: Option
Floor: PVC / Marble

SGM-P028



Ceiling: Golden Mirror Frame , Acrylic Light
Car Wall: Golden Mirror Etching
Handrail: Option
Floor: PVC / Marble



SGM-P030



Ceiling: Golden Mirror Frame, Downlights
Car Wall: Golden Mirror Etching
Handrail: Option
Floor: PVC / Marble





SGM-P031



Ceiling: Golden Mirror Frame, Downlights

Car Wall: Golden Mirror Etching

Handrail: Option

Floor: PVC / Marble

SGM-P032



Ceiling: Golden Mirror Frame, Downlights, Light Belt

Car Wall: Golden Mirror Etching

Handrail: Option

Floor: PVC / Marble





SGM-P033



Ceiling: Golden Mirror Frame , Acrylic
Light,Downlights
Car Wall:Golden Mirror Etching
Handrail: Option
Floor:PVC / Marble



SGM-P035



Ceiling:Golden Mirror Frame,Downlights
Car Wall: Golden Mirror Etching
Handrail:Option
Floor:PVC / Marble

SGM-P034



Ceiling:Golden Mirror Frame,Downlights
Car Wall: Golden Mirror Etching
Handrail: Option
Floor: PVC / Marble



SGM-P036



Ceiling:Golden Mirror Frame,Downlights
Car Wall: Golden Mirror Etching
Handrail: Option
Floor: PVC / Marble

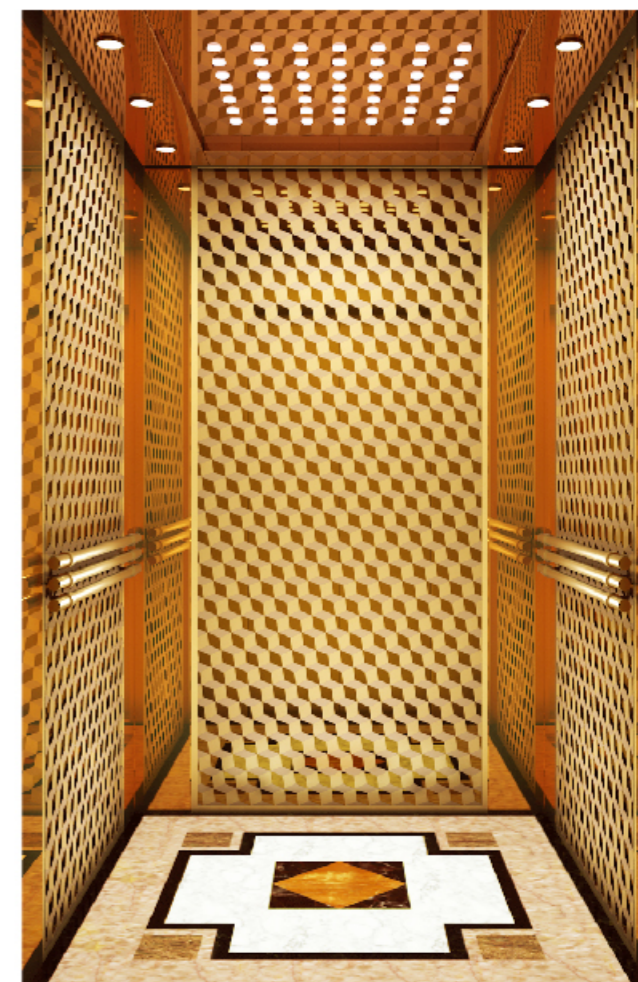



SGM-P037



Ceiling: Golden Mirror Frame , Acrylic Light, Downlights
Car Wall: Golden Mirror Etching
Handrail: Option
Floor: PVC / Marble



SGM-P038



Ceiling: Rose Golden Mirror Frame , Acrylic Light, Downlights
Car Wall: Rose Golden Mirror Etching
Handrail: Option
Floor: PVC / Marble

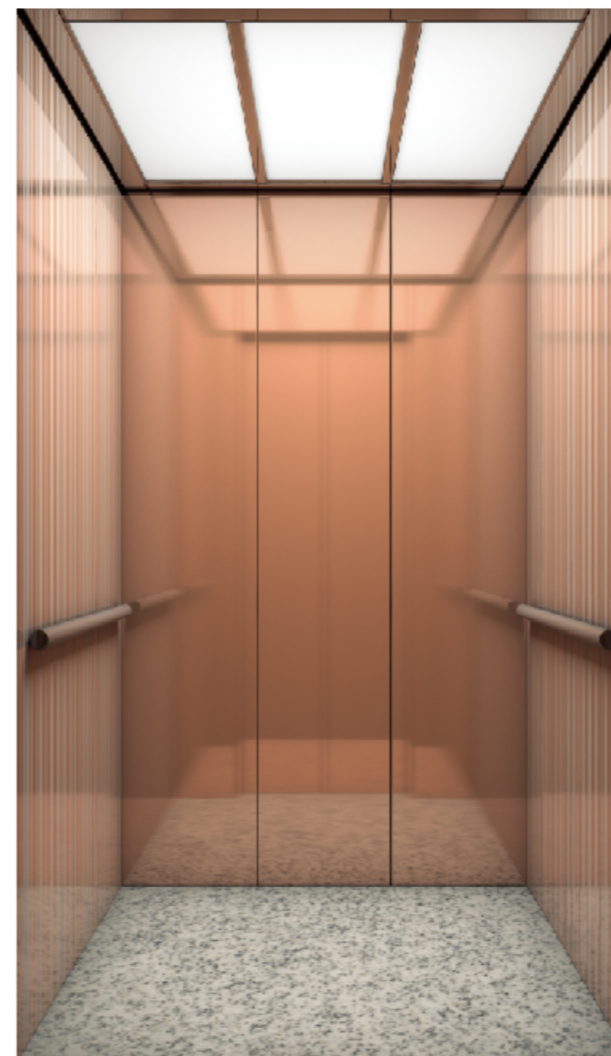

SGM-P039

Ceiling: Rose Golden Mirror Frame , Acrylic Light
Car Wall: Rose Golden Mirror Etching
Handrail: Option
Floor: PVC / Marble

SGM-P040



Ceiling: Rose Golden Mirror Frame , Acrylic Light
Car Wall: Rose Golden Mirror Etching
Handrail: Option
Floor: PVC / Marble





SGM-P041

Ceiling: Rose Golden Mirror Frame , Acrylic Light
Car Wall: Rose Golden Mirror Etching
Handrail: Option
Floor: PVC / Marble



SGM-P042

Ceiling: Rose Golden Mirror Frame , Acrylic Light,
Downlights
Car Wall: Rose Golden Mirror Etching
Handrail: Option
Floor: PVC / Marble



SGM-P043

Ceiling: Black titanium Mirror Frame , Acrylic Light
Car Wall: Black titanium Mirror Etching
Handrail: Option
Floor: PVC / Marble



SGM-P044

Ceiling: Hairline Frame , Acrylic Light
Car Wall: Black titanium Mirror Etching
Handrail: Option
Floor: PVC / Marble



SGM-P045

Ceiling: Black titanium Mirror Frame , Acrylic Light
Car Wall: Black titanium Mirror Etching

Handrail: Option
Floor: PVC / Marble



SGM-P046

Ceiling: Black titanium Mirror Frame , Acrylic Light
Car Wall: Black titanium Mirror Etching
Handrail: Option
Floor: PVC / Marble



SGM-P047

Ceiling: Black titanium Frame , Acrylic Light
Car Wall: Black titanium, Wood grain finish
Handrail: Option
Floor: PVC / Marble

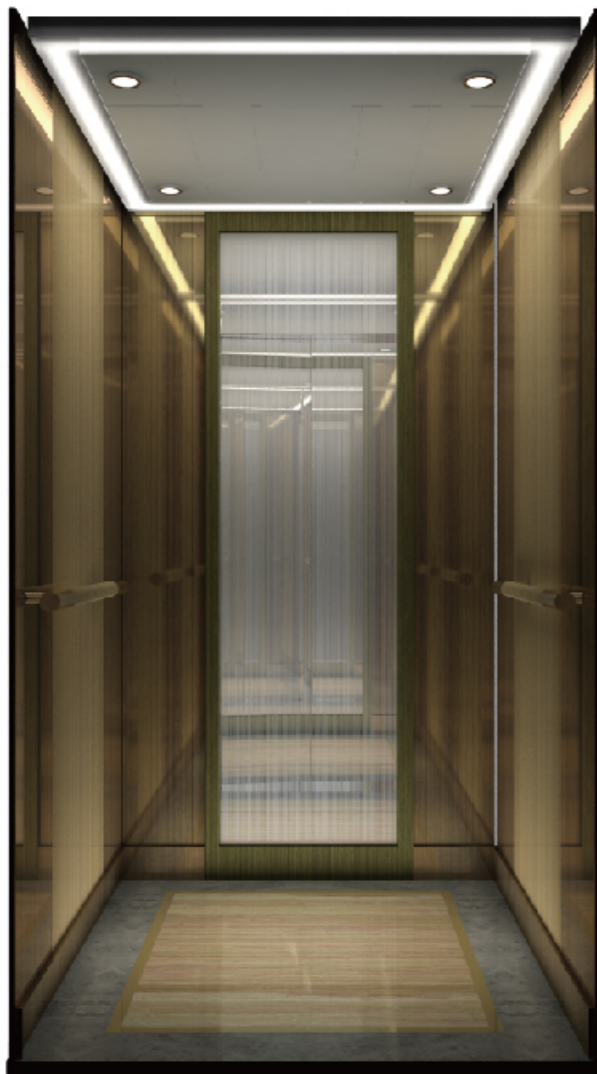

SGM-P048 

Ceiling: Hairline Frame , Acrylic Light
Car Wall: Wood grain finish, Mirror Etching
Handrail: Option
Floor: PVC / Marble



SGM-P049 

Ceiling: Hairline Frame , Black titanium mirror, Down Light
Car Wall: Hairline, Black Titanium Mirror Etching
Handrail: Option
Floor: PVC / Marble



 SGM-P050

Ceiling: Black Titanium Mirror Frame , Down Light
Car Wall: Black Titanium Mirror Etching
Handrail: Option
Floor: PVC / Marble

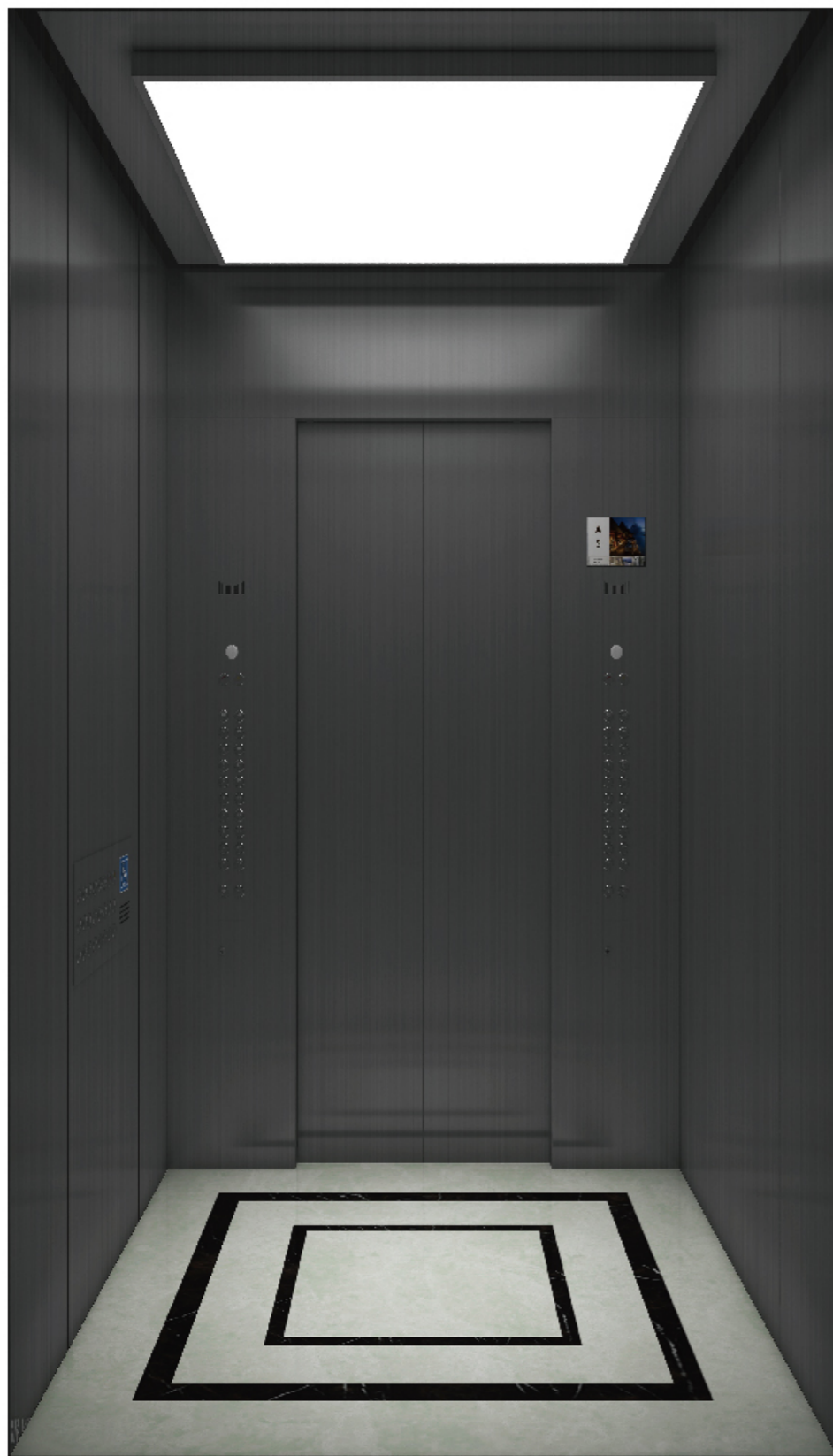

SGM-P051

Ceiling: Black Titanium Frame , Acrylic Light
Car Wall: Black Titanium Hairline

Handrail:Option
Floor: PVC / Marble



SGM-P052

Ceiling: Black Titanium Mirror Frame , Acrylic Light
Car Wall: Black Titanium Mirror Etching
Handrail: Option
Floor: PVC / Marble



SGM-P053

Ceiling: Mirror Frame , Acrylic Light
Car Wall: Black champagne gold
Handrail:Option
Floor: PVC / Marble



part
03

奢华型乘客轿厢
LUXURY PASSENGER CAR



SGM-P054



Ceiling: Black Titanium Mirror Frame , Acrylic Light

Car Wall: Black Titanium Mirror Etching

Handrail: Opition

Floor: PVC / Marble

精致的图案，优雅的色彩，将富丽典雅搭配出美艳灼人的高贵气质，赋予您尊贵的身份象征。



SGM-P055



Ceiling: Hairline Frame , Acrylic Light
Car Wall: Hairline
Handrail: Option
Floor: PVC / Marble



SGM-P053



Ceiling: Black Titanium Mirror Frame , Acrylic Light
Car Wall: Black Titanium Mirror Etching
Handrail: Option
Floor: PVC / Marble



SGM-P056



Ceiling: Hairline Frame , Acrylic Light
Car Wall: Black walnut grain
Handrail: Option
Floor: PVC / Marble



SGM-P057



Ceiling: Black Titanium Mirror Frame , Acrylic Light
Car Wall: Black Titanium Mirror
Handrail: Option
Floor: PVC / Marble



SGM-P058



Ceiling: Black Titanium Mirror Frame , Acrylic Light

Car Wall: Black Titanium Mirror Etching

Handrail: Option

Floor: PVC / Marble



SGM-P059



Ceiling: Black Titanium Mirror Frame , Acrylic Light

Car Wall: Black Titanium Mirror Etching

Handrail: Option

Floor: PVC / Marble



SGM-P060



Ceiling:Black Titanium Frame ,
Acrylic Light

Car Wall:Black Titanium Mirror
Etching

Handrail:Option

Floor: PVC / Marble

OPERATION PANDEL SERIES



人机系列
HUMAN MACHINE SERIES



SGM-C001



SGM-CW001



SGM-C002



SGM-CW002

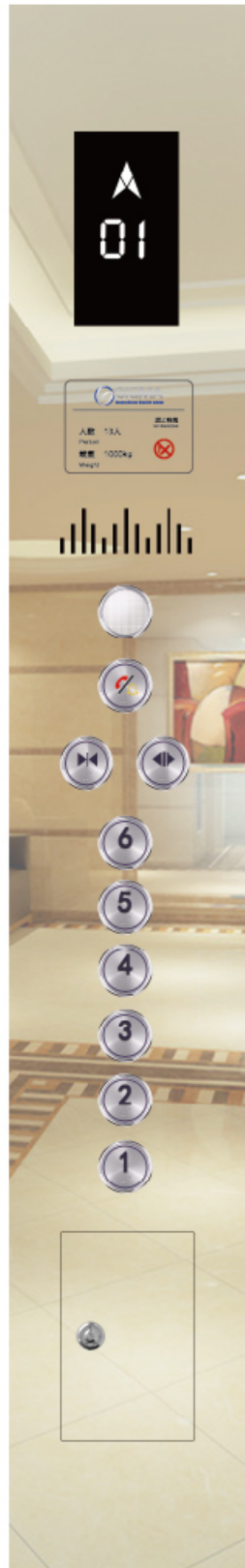

SGM-C003



SGM-CW003



SGM-C004



SGM-CW004

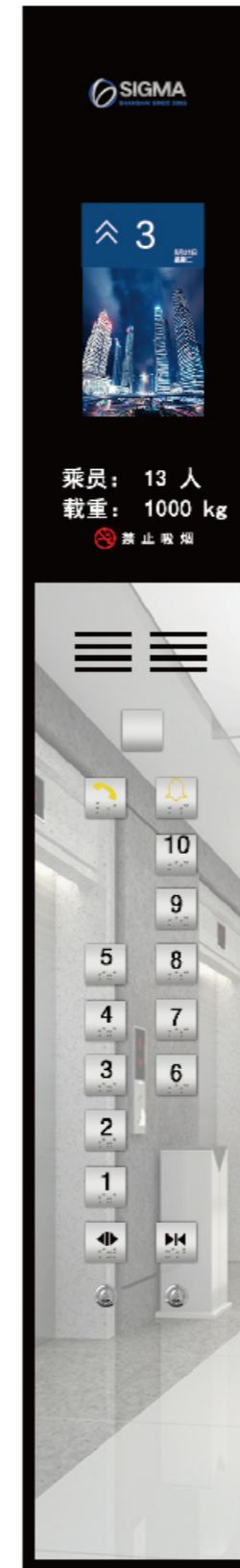

SGM-C005



SGM-CW005

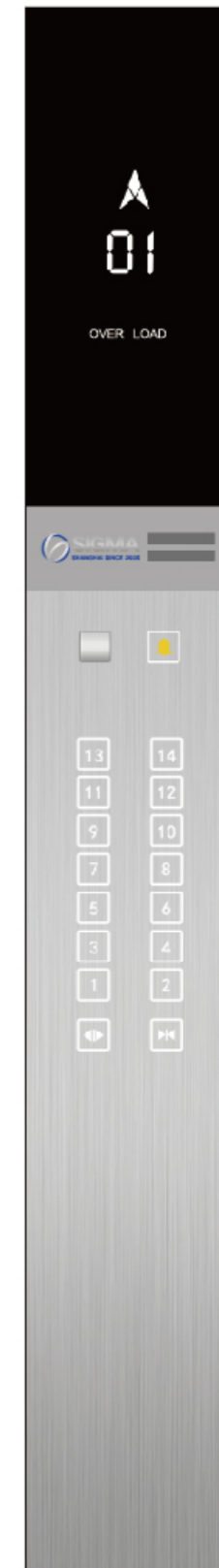

SGM-C006



SGM-CW006



Call box (No bottom box series)



SGM-WH01 SGM-WH02 SGM-WH03 SGM-WH04 SGM-WH05 SGM-WH06

Call lantern series Outside the hall monitor



▷ SGM-DD2001

Mirror stainless steel, acrylic, LED downlight

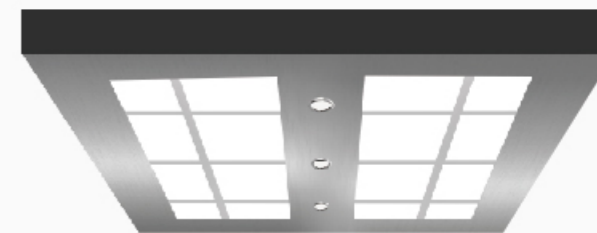

◁ SGM-DD2002

Mirror stainless steel, acrylic, LED downlight

▷ SGM-DD2003

Mirror stainless steel, acrylic, LED downlight



◁ SGM-DD2004

Mirror stainless steel, acrylic

▷ SGM-DD2005

White arch light-emitting panel, stainless steel mirror flame, strip light decoration

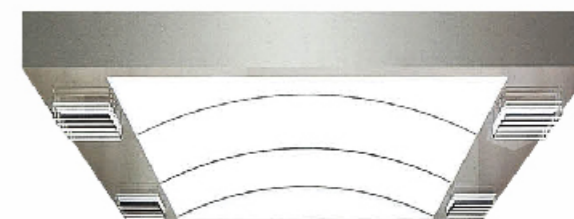

多变的风格设计，过硬的品质把关，每个细节都极致呈现，抬头就能看得到的艺术。

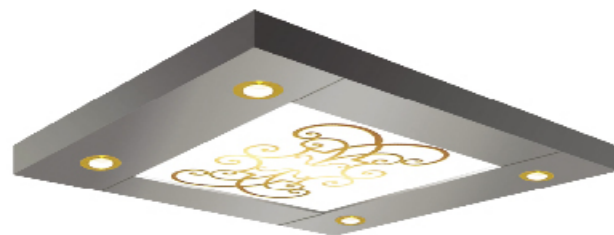

Ⓐ SGM-DD2006

The middle image is flat on both sides, for soft illumination design of stainless steel floor with downlight



Ⓐ SGM-DD2007

Double-arch white organic light-emitting panel, central soft lighting design of down lamp



Ⓐ SGM-DD2014

Painted steel plate frame , white acrylic light-emitting

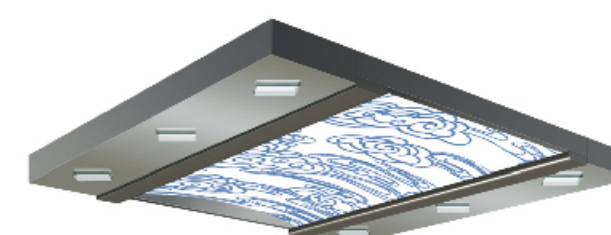

Ⓐ SGM-DD2015

Soft lighting design and image roof on both sides of rhombic hollow transparent lamp post

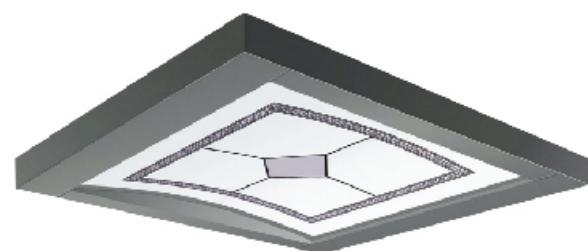

Ⓐ SGM-DD2008

Soft lighting design of wide image dome

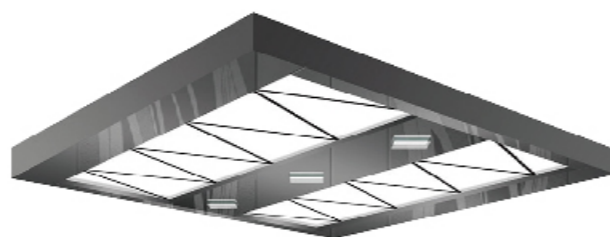

Ⓐ SGM-DD2009

Mirror stainless steel, acrylic

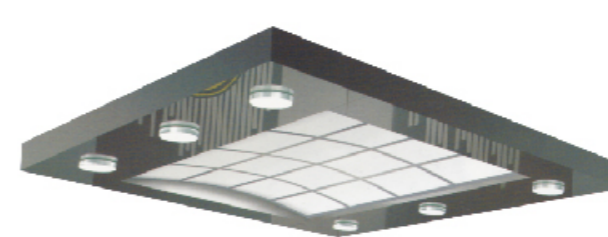

Ⓐ SGM-DD2016

Cylindrial hollow transparent light pole , soft lighting design of arcy white light-emitting panel



Ⓐ SGM-DD2017

Steel plate plaxtic-jet frame , acrylic lighting decoration

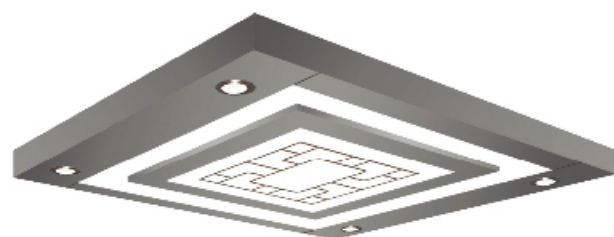

Ⓐ SGM-DD2010

Hanging lamp board and soft lighting design with square image subject downlight

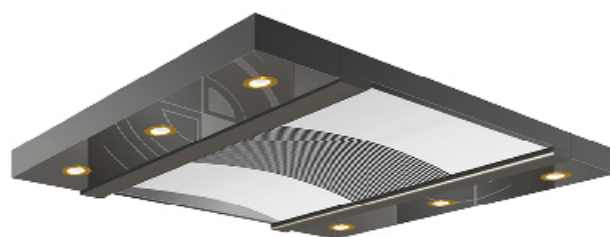

Ⓐ SGM-DD2011

The middle image roof, both sides for soft illumination design of stainless steel floor with downlight

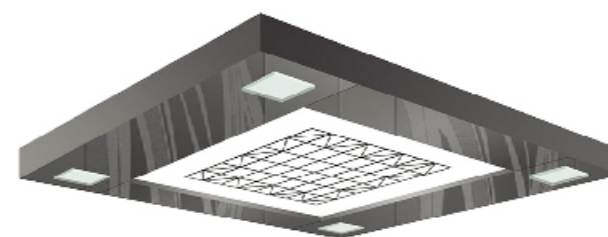

Ⓐ SGM-DD2018

The middle image is flat , soft lighting design of stainless steel floor with hollow diamond transparent lamp



Ⓐ SGM-DD2019

Soft lighting design of middle column and the dolder white acrylic lamp

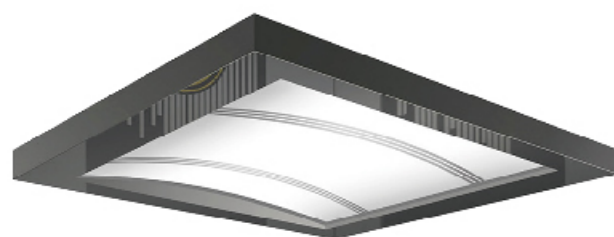

Ⓐ SGM-DD2012

Soft lighting design of broad arch white light-emitting panel

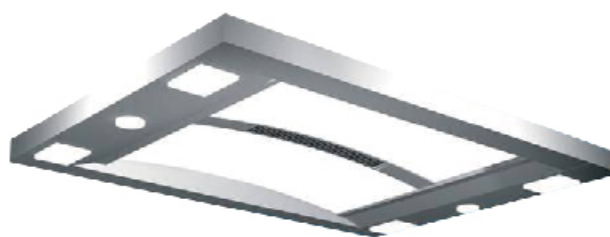

Ⓐ SGM-DD2013

Stainless steel frame, central arch acrylic lighting decoration

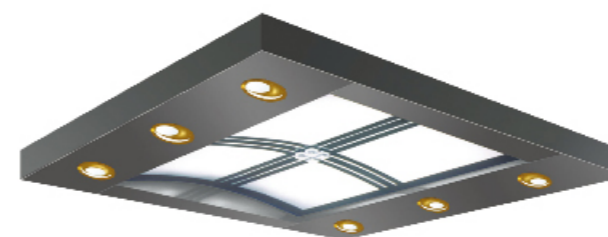

Ⓐ SGM-DD2020

In the spraying steel plate floor with golden bridge wall shine tube lamp and the middle part is soft lighting design of the arch white organic transparent plate

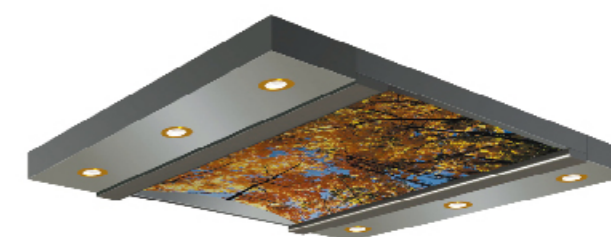

Ⓐ SGM-DD2021

The middle image roof , both sides for soft illumination design of stainless steel floor with downlight (image can provide)

part
07

厅门系列
LANDING DOOR SERIES



SGM-M001
Mirror, hairline



SGM-M002
Mirror, hairline



SGM-M003
Mirror, etching



SGM-M004
Mirror, etching



SGM-M005
Mirror, etching



SGM-M006
Mirror, etching

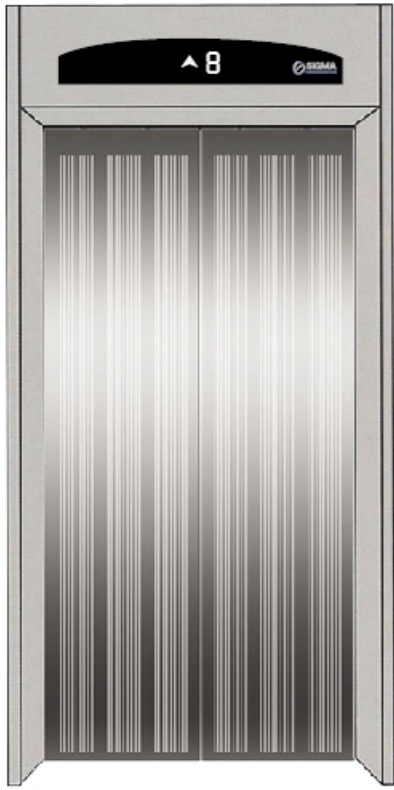

SGM-M007
Mirror, etching



SGM-M008
Mirror, hairline, etching



SGM-M009
Mirror, etching



SGM-M013
Mirror, etching, irregular grain



SGM-M014
Hairline, etching, titanium

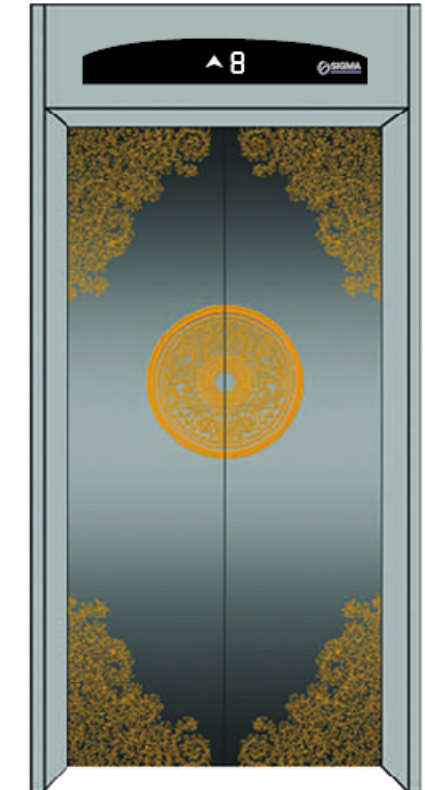

SGM-M015
Mirror, etched, hairline,
Irregular grain, titanium gold



SGM-M010
Mirror, etching

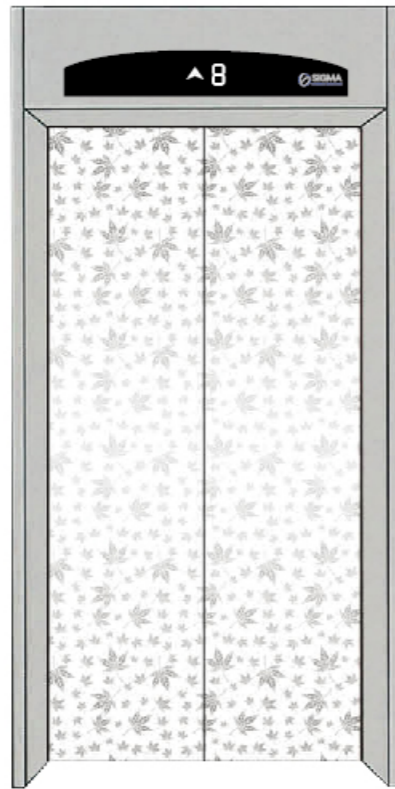

SGM-M011
Mirror, etching



SGM-M012
Mirror, etching



SGM-M016
Etched, hairline, titanium gold



SGM-M017
Mirror, etching



SGM-M018
Mirror, etching, hairline



SGM-M019
Mirror,etching



SGM-M020
Mirror,etching,hairline



SGM-M021
Mirror,etching,hairline



SGM-M025
Mirror,etching



SGM-M026
Mirror,etching,hairline



SGM-M027
Etching,hairline



SGM-M022
Mirror,etching,hairline



SGM-M023
Mirror,etching,hairline



SGM-M024
Mirror,etching,hairline



SGM-M028
Mirror,etching,hairline



SGM-M029
Mirror,etching,hairline



SGM-M030
Mirror,etching

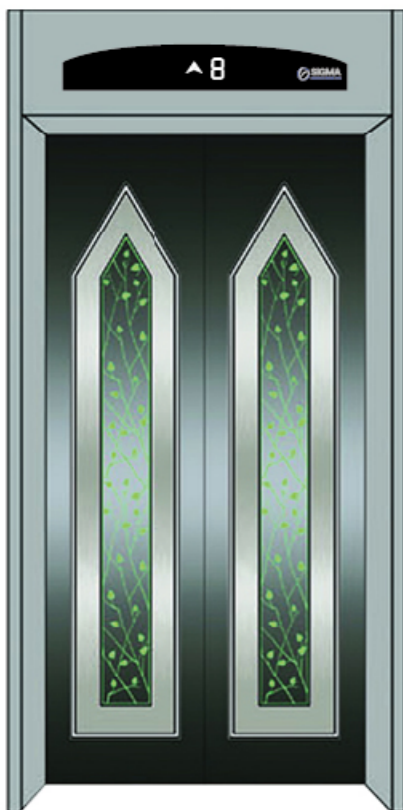

SGM-M031

Hairline, etching

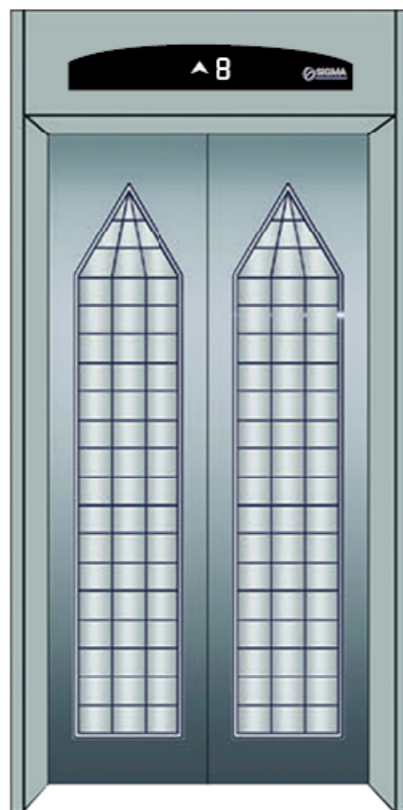

SGM-M032

Hairline, etching

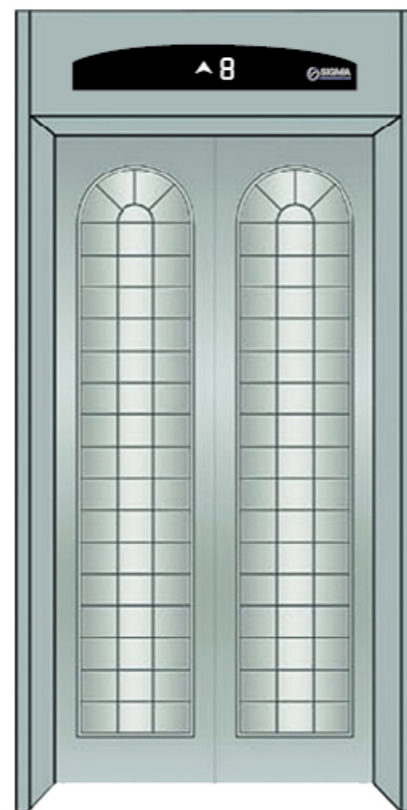

SGM-M033

Mirror, etching



SGM-M037

Hairline, etching



SGM-M038

Hairline, etching

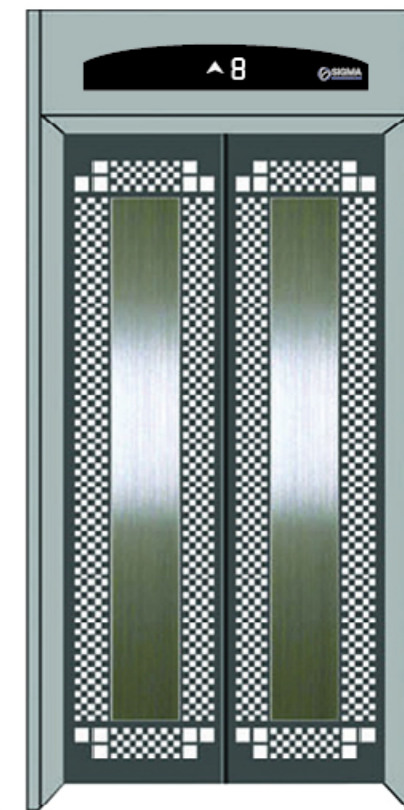

SGM-M039

Hairline, etching

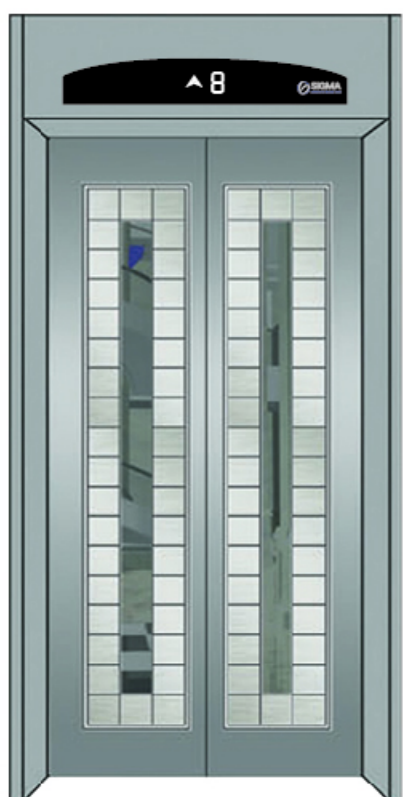

SGM-M034

Mirror, hairline, etching



SGM-M035

Mirror, hairline, etching



SGM-M036

Mirror, etched



SGM-M040

Mirror, etched, irregular grain



SGM-M041

Mirror, etched, irregular grain

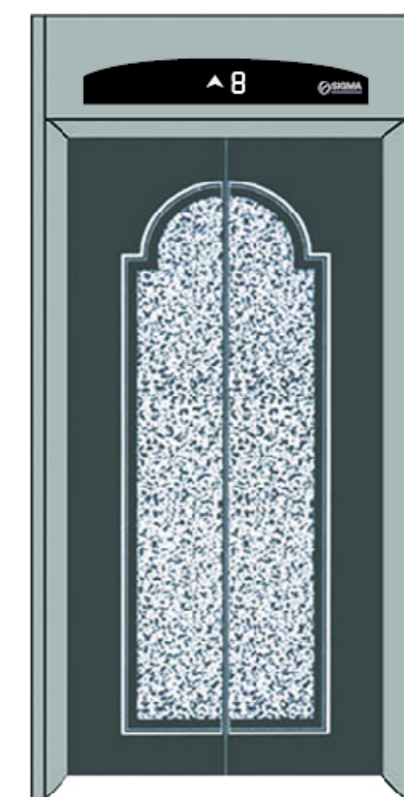

SGM-M042

Mirror, etched



SGM-M043

Hairline, etching

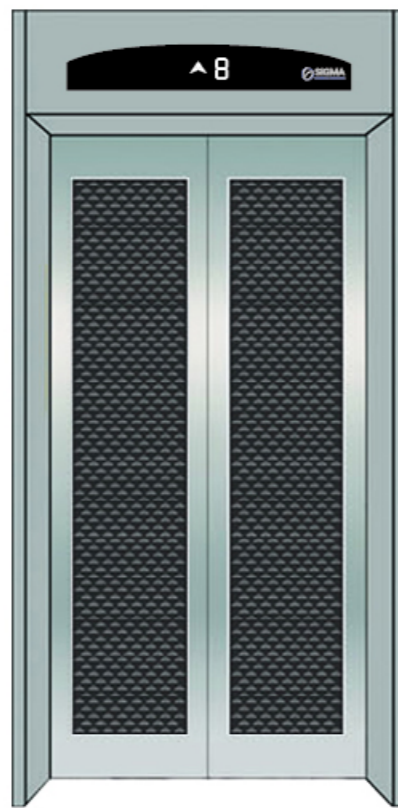

SGM-M044

Hairline, etching



SGM-M045

Mirror, etched

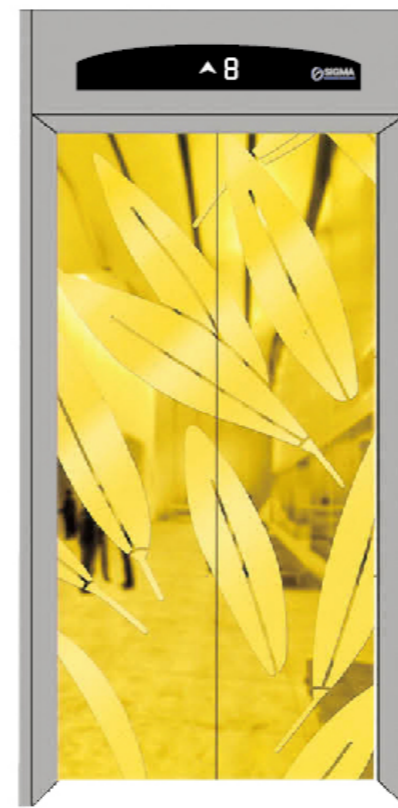

SGM-M049

Titanium gold,mirror,etched

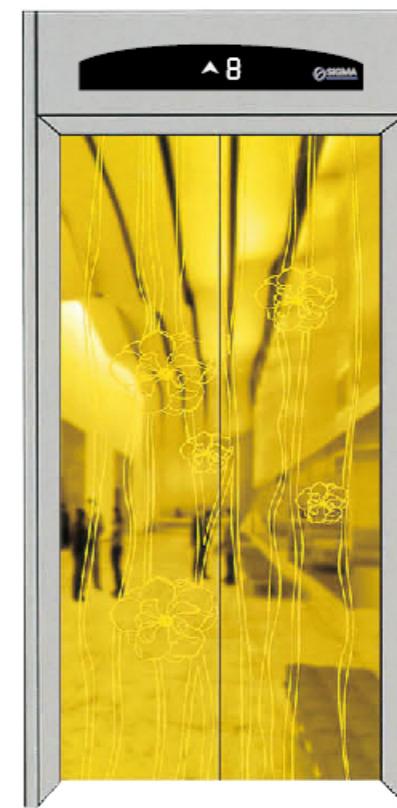

SGM-M050

Titanium gold,mirror,etched

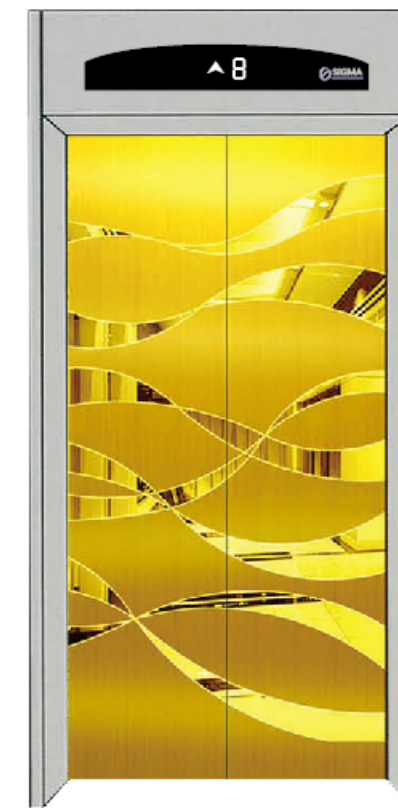

SGM-M051

titanium,mirror,etched,hairline,
Irregular grain

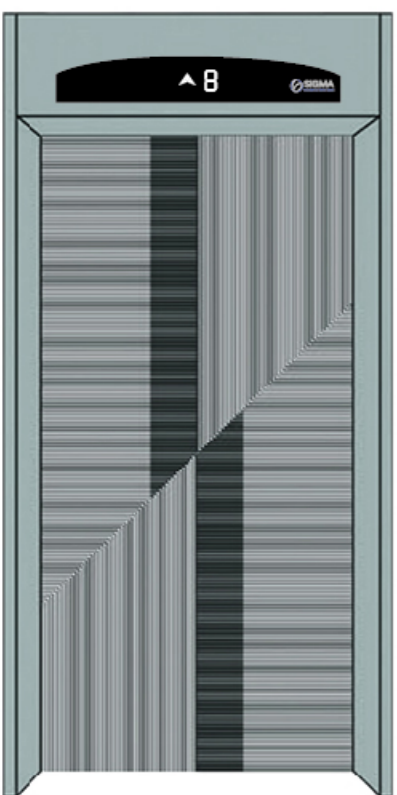

SGM-M046

Hairline, etching

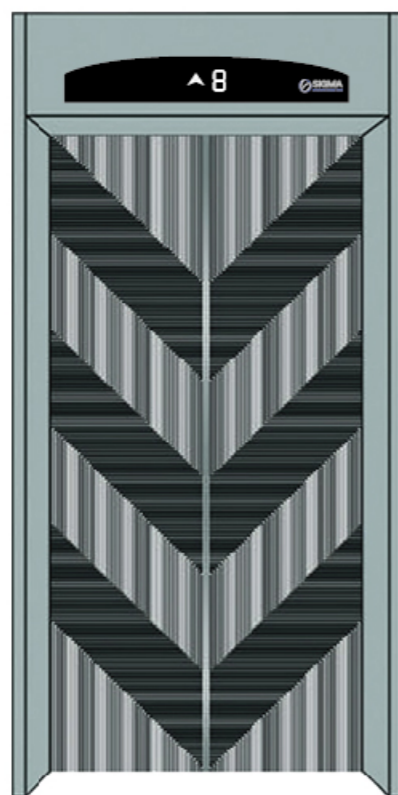

SGM-M047

Hairline, etching

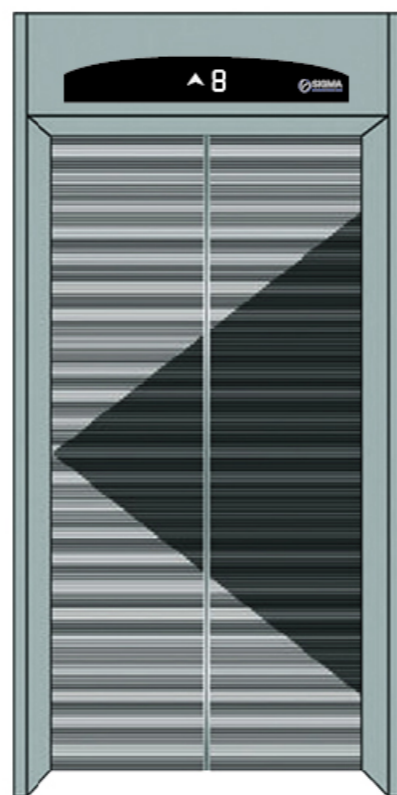

SGM-M048

Hairline, etching



SGM-M052

Titanium gold,mirror,etched

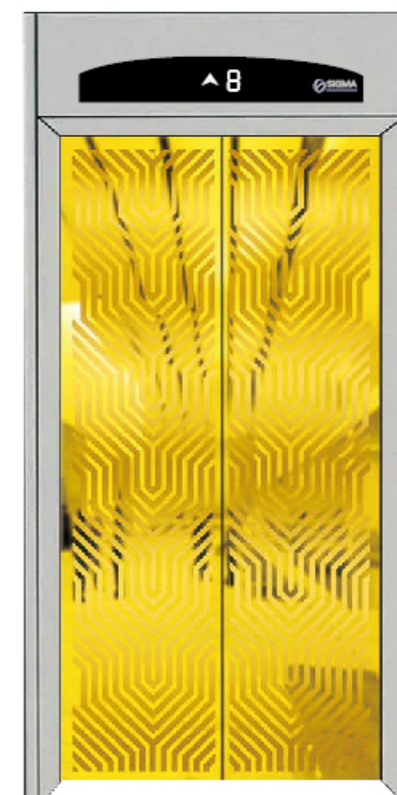

SGM-M053

Titanium gold,mirror,etched



SGM-M054

Titanium gold,mirror,etched



SGM-M055
Titanium gold,mirror,etched



SGM-M056
Titanium gold,mirror,etched



SGM-M057
Titanium gold,mirror,etched



SGM-M061
Titanium gold,mirror,etched



SGM-M062
Titanium gold,mirror,etched

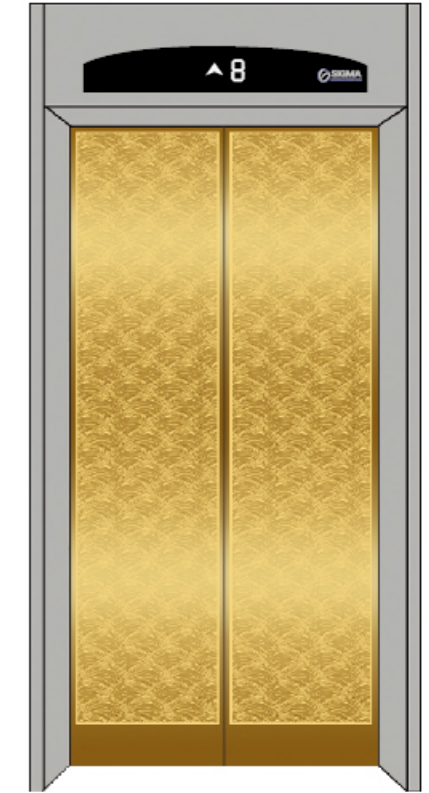

SGM-M063
Titanium gold,mirror,etched



SGM-M058
Titanium gold,mirror,etched



SGM-M059
Titanium gold,mirror,etched

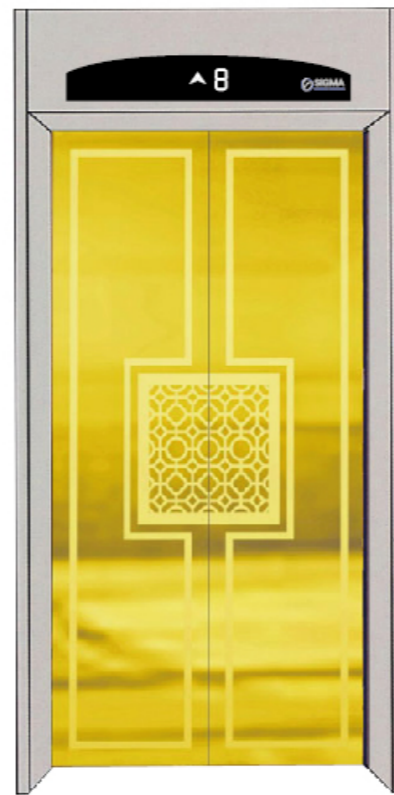

SGM-M060
Titanium gold,mirror,etched



SGM-M064
Titanium gold,mirror,etched

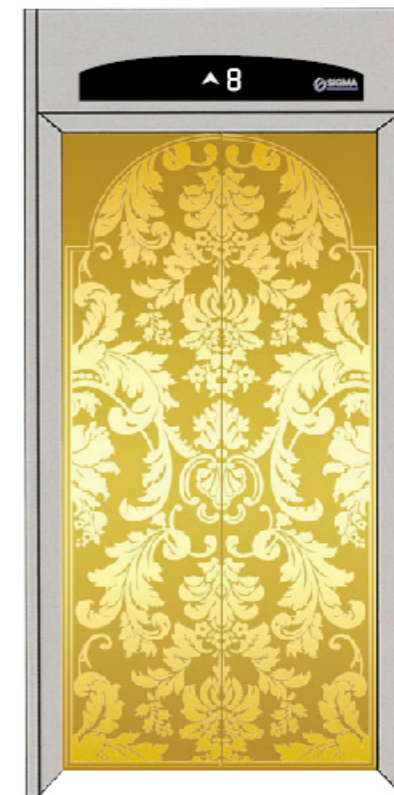

SGM-M065
Titanium gold,mirror,etched



SGM-M066
Titanium gold,mirror,etched

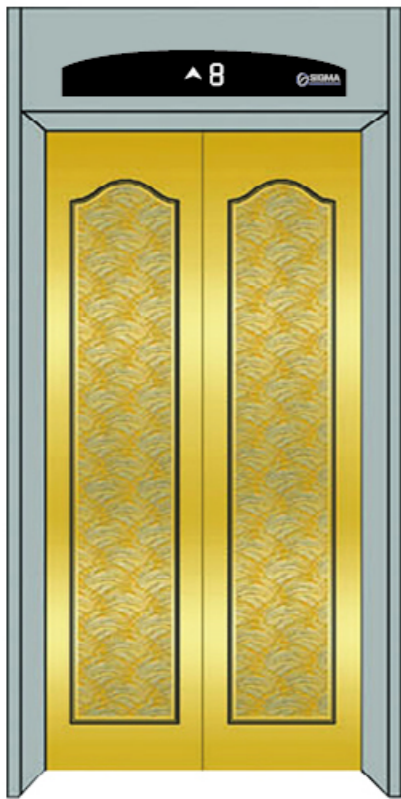

SGM-M067
Titanium gold, etching

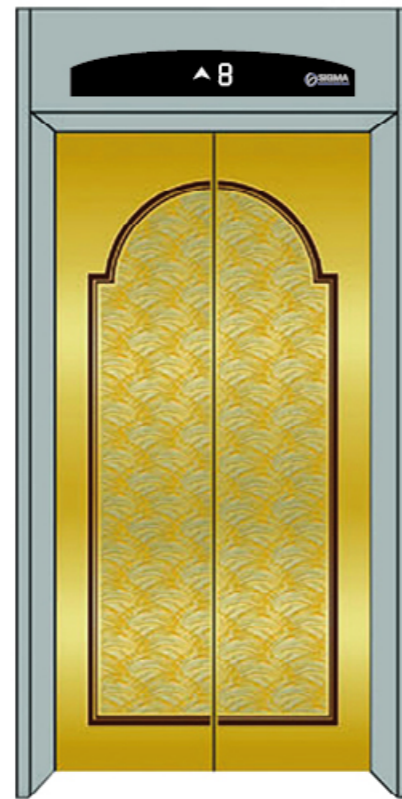

SGM-M068
Titanium gold, etching

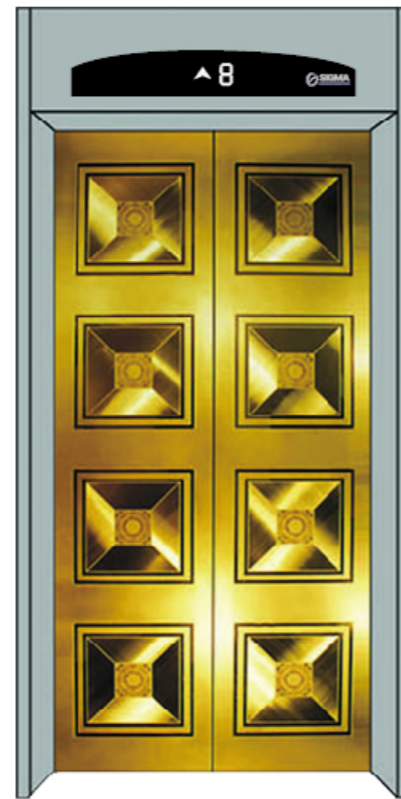

SGM-M069
Titanium gold, etching



SGM-M073
Rose gold, etching

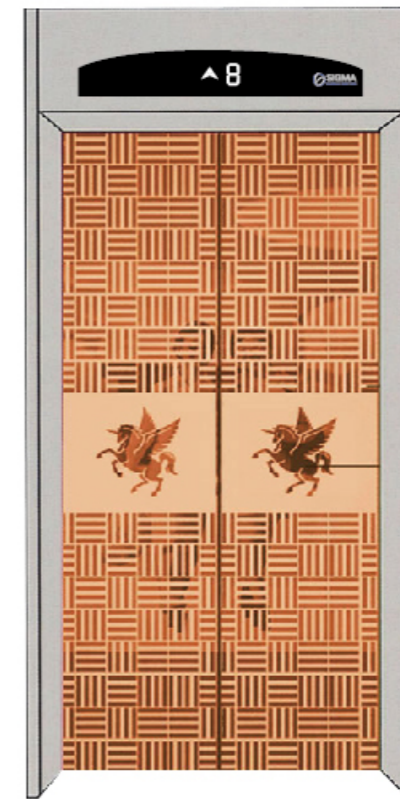

SGM-M074
Rose gold, etching



SGM-M075
Rose gold, etching



SGM-M070
Titanium gold, etching



SGM-M071
Titanium, mirror, etching, Irregular grain



SGM-M072
Titanium, mirror, etching, Irregular grain



SGM-M076
Rose gold, etching



SGM-M077
Rose gold, etching



SGM-M078
Rose gold, etching

扶手系列
HANDRAIL SERIES

③ SGM-F2001
Hairline stainless steel



③ SGM-F2002
Titanium gold stainless steel



③ SGM-F2003
Stainless steel double pipe



③ SGM-F2004
Titanium gold stainless steel
double pipe



③ SGM-F2005
Titanium gold stainless steel
flat handrail



简单而不失大气，由内而外散发的至尊气息，方寸之间，尽显魅力。

➤ SGM-F2006

Combination of solid wood and titanium



➤ SGM-F2007

Combination of solid wood and titanium



➤ SGM-F2008

Titanium stainless steel round pipe triple handrail



➤ SGM-F2009

Hairline stainless steel flat handrail



➤ SGM-F2010

Titanium gold stainless steel flat handrail



➤ SGM-F2011

Solid wood elbow flat handrail



➤ SGM-F2012

Combination of solid wood and hairline



➤ SGM-F2013

Process combination of titanium hairline mirror



➤ SGM-F2014

Organic glass titanium alloy combination



➤ SGM-F2015

Organic glass titanium alloy combination



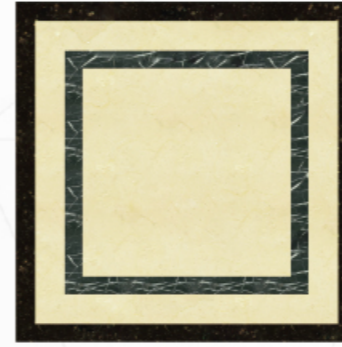

SGM-DB2001

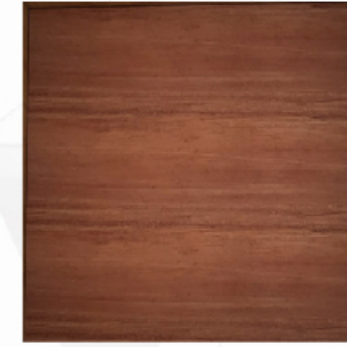

SGM-DB2002



SGM-DB2003

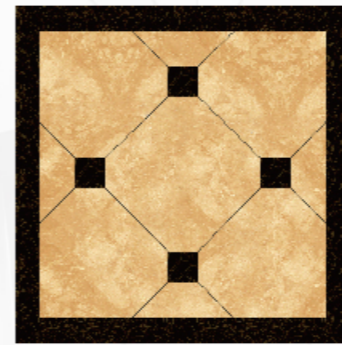

SGM-DB2004

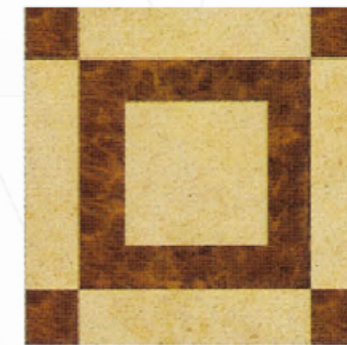

SGM-DB2005

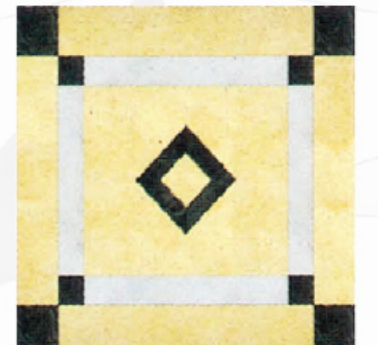

SGM-DB2006

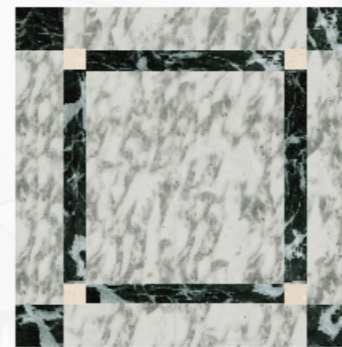

SGM-DB2007

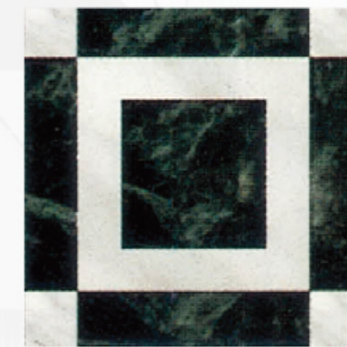

SGM-DB2008



SGM-DB2009

地板系列
FLOOR SERIES

精致、精品、经典，于不经意间触动心弦。让脚下的每一处风景都无憾。

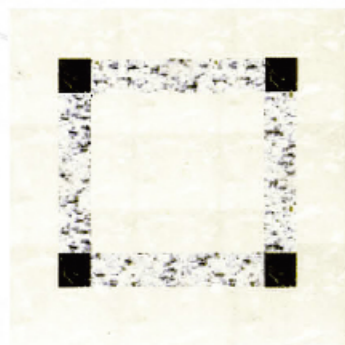

SGM-DB2010



SGM-DB2011



SGM-DB2012



SGM-DB2019



SGM-DB2020

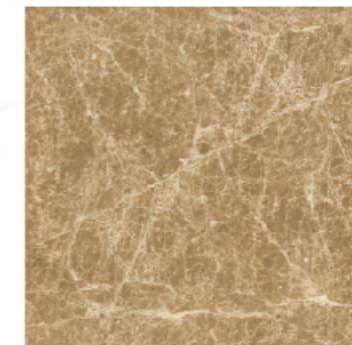

SGM-DB2021



SGM-DB2013

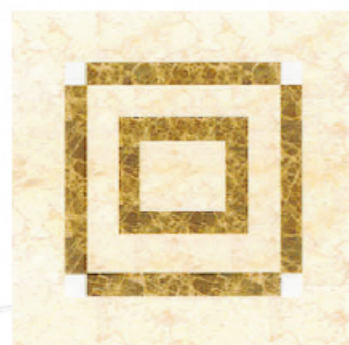

SGM-DB2014



SGM-DB2015



SGM-DB2022

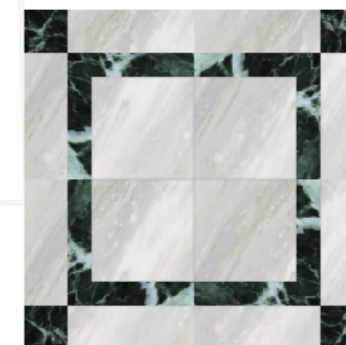

SGM-DB2023



SGM-DB2024



SGM-DB2016

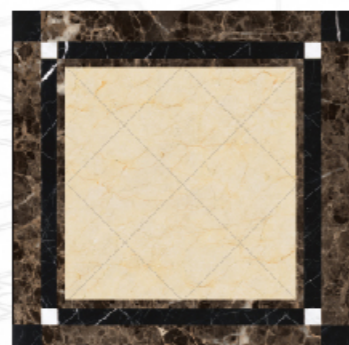

SGM-DB2017

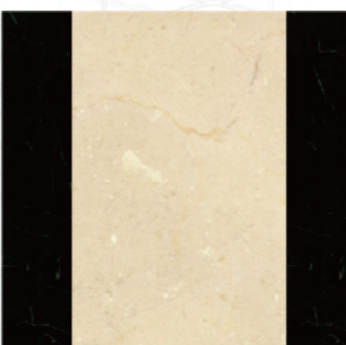

SGM-DB2018



SGM-DB2025



SGM-DB2026



SGM-DB2027

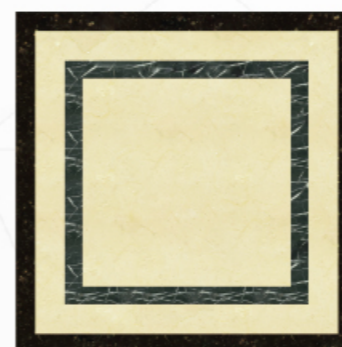

SGM-DB2001

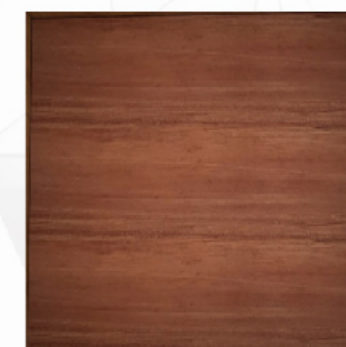

SGM-DB2002



SGM-DB2003

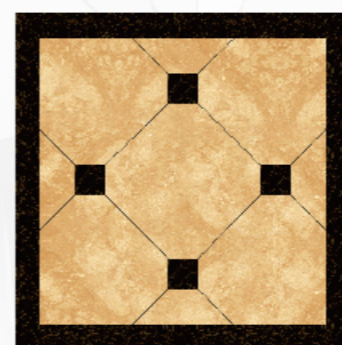

SGM-DB2004



SGM-DB2005

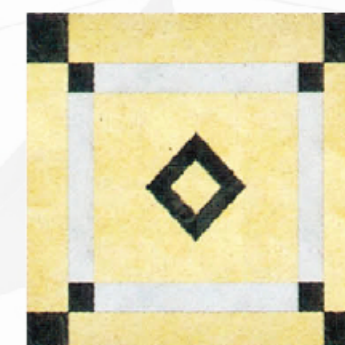

SGM-DB2006



SGM-DB2007

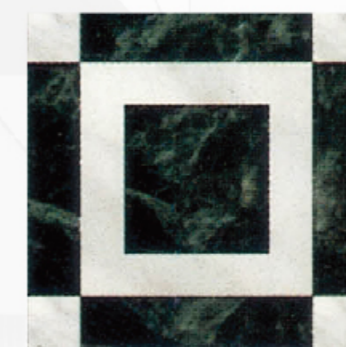

SGM-DB2008

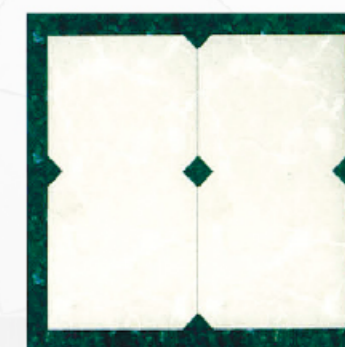

SGM-DB2009

地板系列
FLOOR SERIES

part 10

精致、精品、经典，于不经意间触动心弦。让脚下的每一处风景都无憾。

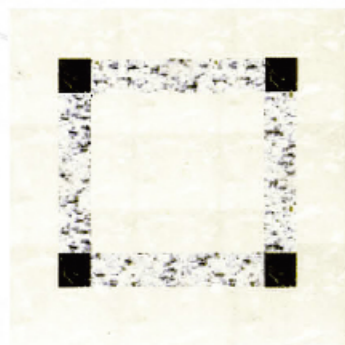

SGM-DB2010



SGM-DB2011



SGM-DB2012



SGM-DB2019



SGM-DB2020

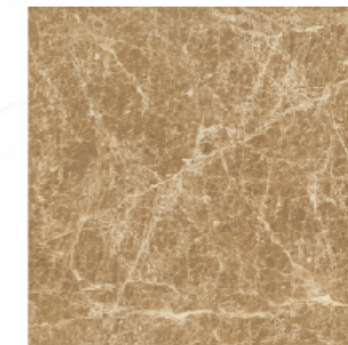

SGM-DB2021



SGM-DB2013

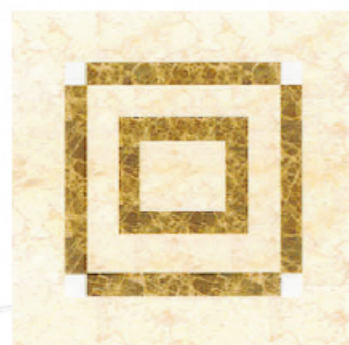

SGM-DB2014



SGM-DB2015



SGM-DB2022

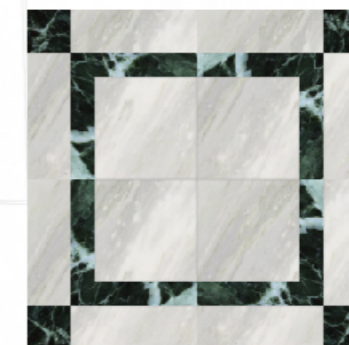

SGM-DB2023



SGM-DB2024



SGM-DB2016

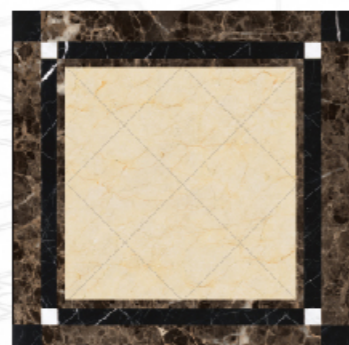

SGM-DB2017

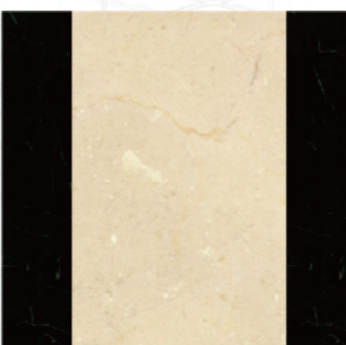

SGM-DB2018



SGM-DB2025



SGM-DB2026



SGM-DB2027

ESCALATOR AND MOVING WALK DECORATION

The decorative materials of escalator are aluminium plastic plate, aluminium veneer, hairline stainless steel, 8K mirror stainless steel plate, etc. The overall effect is simple and the lines are bright.

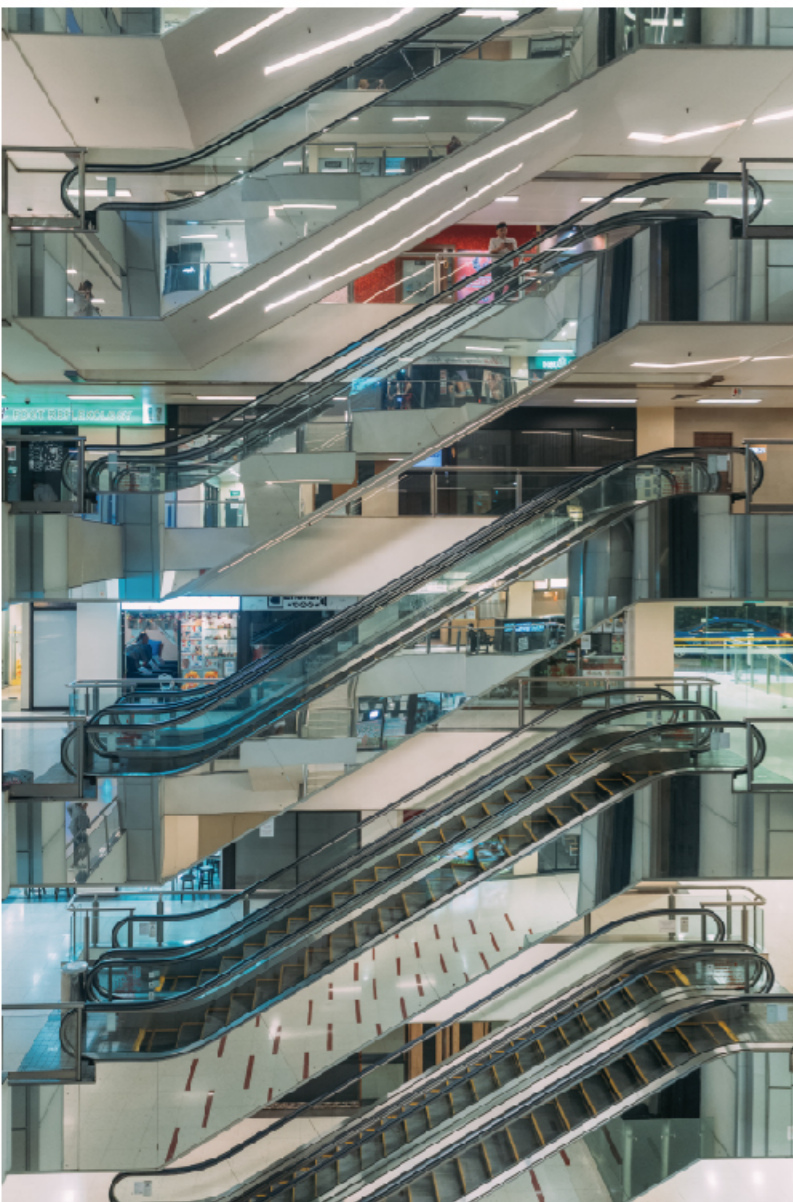

侧壁镜面不锈钢板装饰
底板喷涂板 + LED装饰条

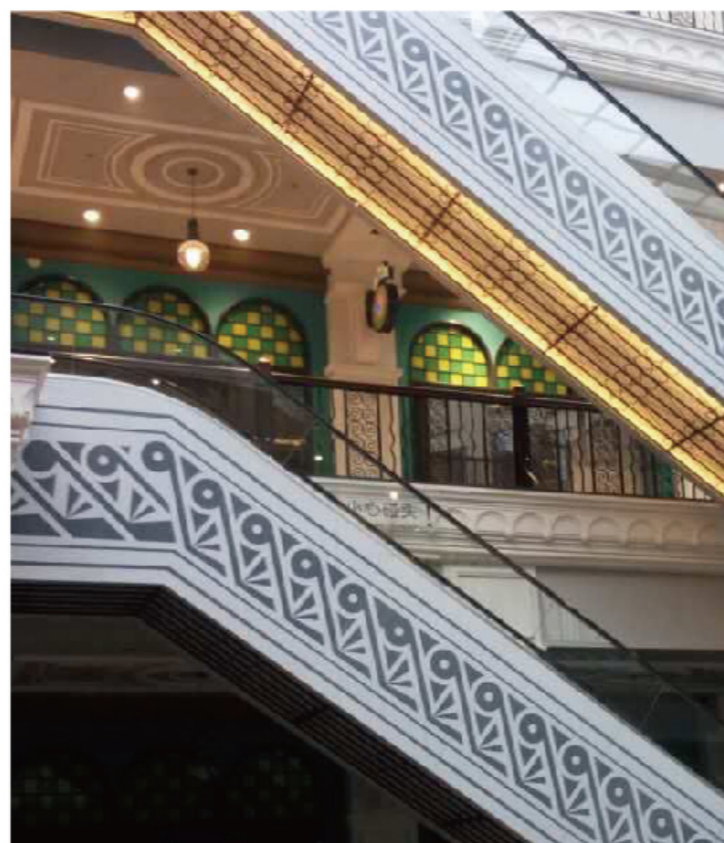

装饰侧板：镜面蚀刻不锈钢
装饰地板：钛金镜面蚀刻不锈钢暗藏LED灯带



侧壁不锈钢板装饰



侧壁铝塑板装饰



侧壁喷涂钢板装饰



侧壁玻璃板装饰

30° ESCALATOR CONSTRUCTION SKETCH

30° 自动扶梯土建图

35° ESCALATOR CONSTRUCTION SKETCH

35° 自动扶梯土建图

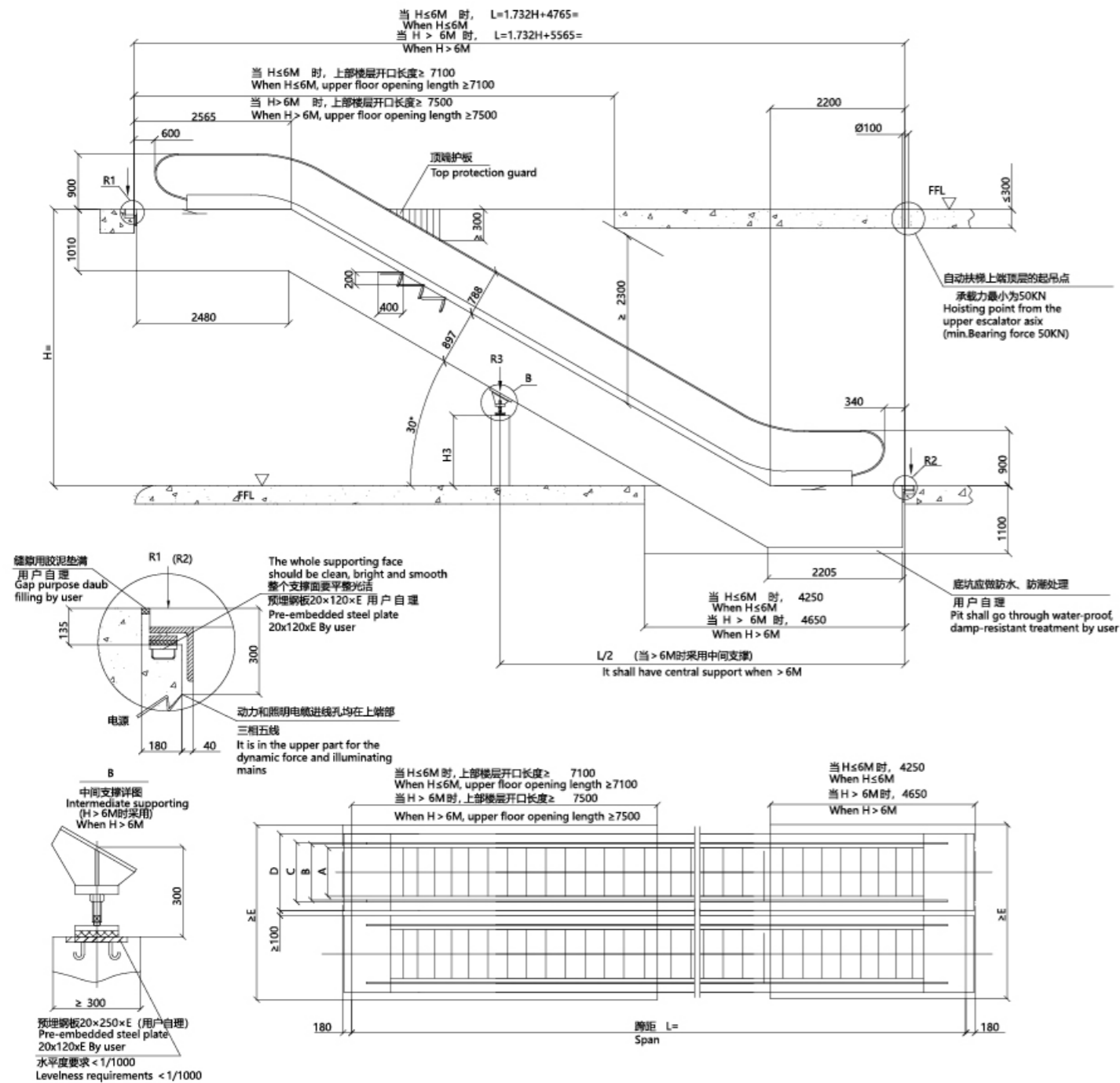

型号 Model	提升高度 Travelling height (mm)	净重 Net weight (KN)	支持力 supporting R1 KN R2 KN	电机功率 Motor power KW	运输尺寸 Transport size h l
VF800/0.5-30° (4800人/h) 速度: 0.5m/s speed: 0.5m/s	3000	118	104 94	2750	10900
	3500	126	112 100	5.5	2780 11890
	4000	134	120 108		2810 12880
	4500	142	128 114		2830 13870
	5000	148	136 120	8	2840 14860
	5500	164	148 132		2860 15860
VF1000/0.5-30° (6000人/h) 速度: 0.5m/s speed: 0.5m/s	3000	126	118 106	5.5	2750 10900
	3500	134	128 114		2780 11890
	4000	142	136 122	8	2810 12880
	4500	150	146 130		2830 13870
	5000	166	158 142		2840 14860
	5500	174	168 150	11	2860 15860
6000	184	176 158		2870 16850	

1000	1000	1228	1238	1600	3400
800	800	1028	1038	1400	3000
梯级宽度mm step width	A	B	C	D	E
中间支撑距H3 Intermediate supporting	$(L/2-2600) \times \tan 30^\circ - (897/\cos 30^\circ + 300)$				

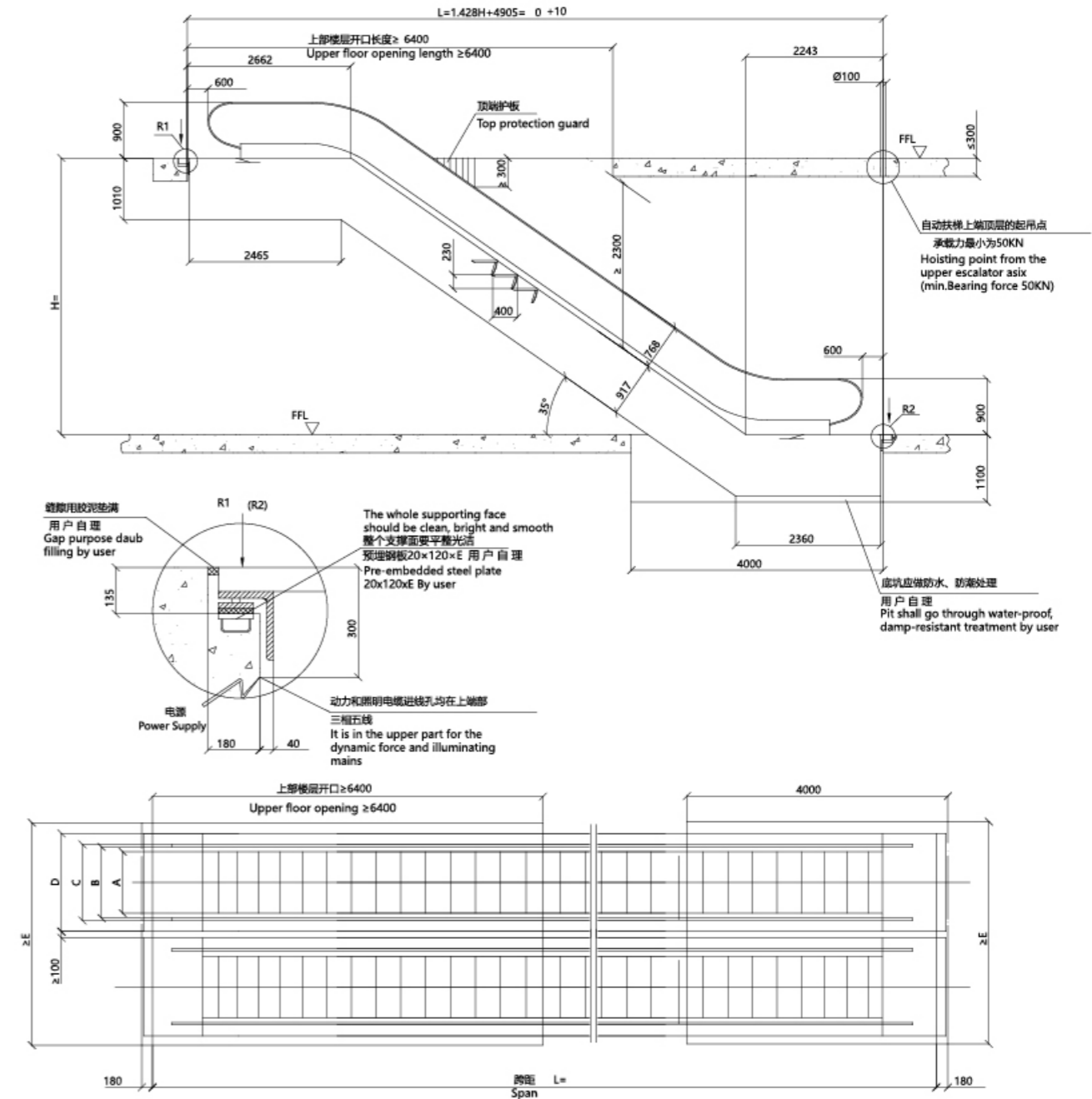
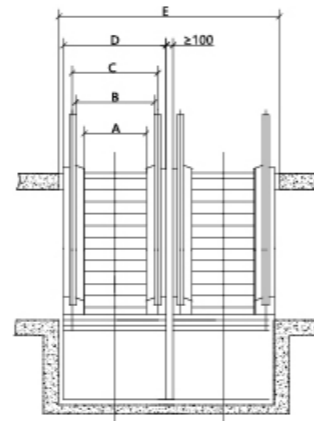

型号 Model	提升高度 Travelling height (mm)	净重 Net weight (KN)	支持力 supporting R1 KN R2 KN	电机功率 Motor power KW	运输尺寸 Transport size h l
VF800/0.5-35° (4800人/h) 速度: 0.5m/s speed: 0.5m/s	3000	112	98 88	2750	10180
	3500	120	104 94	5.5	2890 11030
	4000	126	112 100		2920 11890
	4500	132	118 106		2940 12750
	5000	140	124 112	8	2970 13610
	5500	146	130 118		2980 14470
VF1000/0.5-35° (6000人/h) 速度: 0.5m/s speed: 0.5m/s	3000	120	112 100	5.5	2850 10180
	3500	128	120 106		2890 11030
	4000	134	128 114	8	2920 11890
	4500	142	134 120		2940 12750
	5000	148	142 128		2970 13610
	5500	158	154 138	11	2980 14470
6000	166	162 144		3000 15330	

1000	1000	1228	1238	1600	3400
800	800	1028	1038	1400	3000
梯级宽度mm step width	A	B	C	D	E

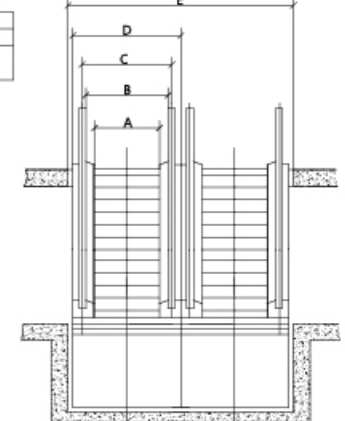

12° MOVING WALK CONSTRUCTION SKETCH

12° 自动人行道土建图

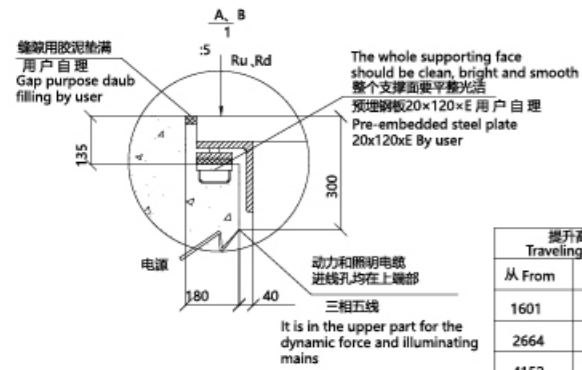
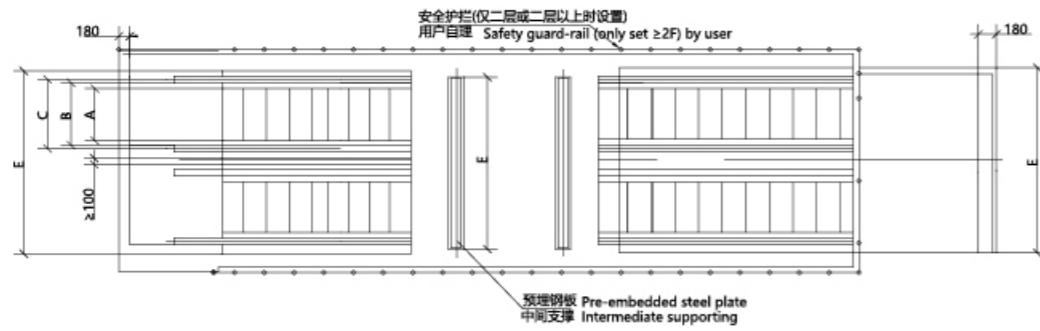
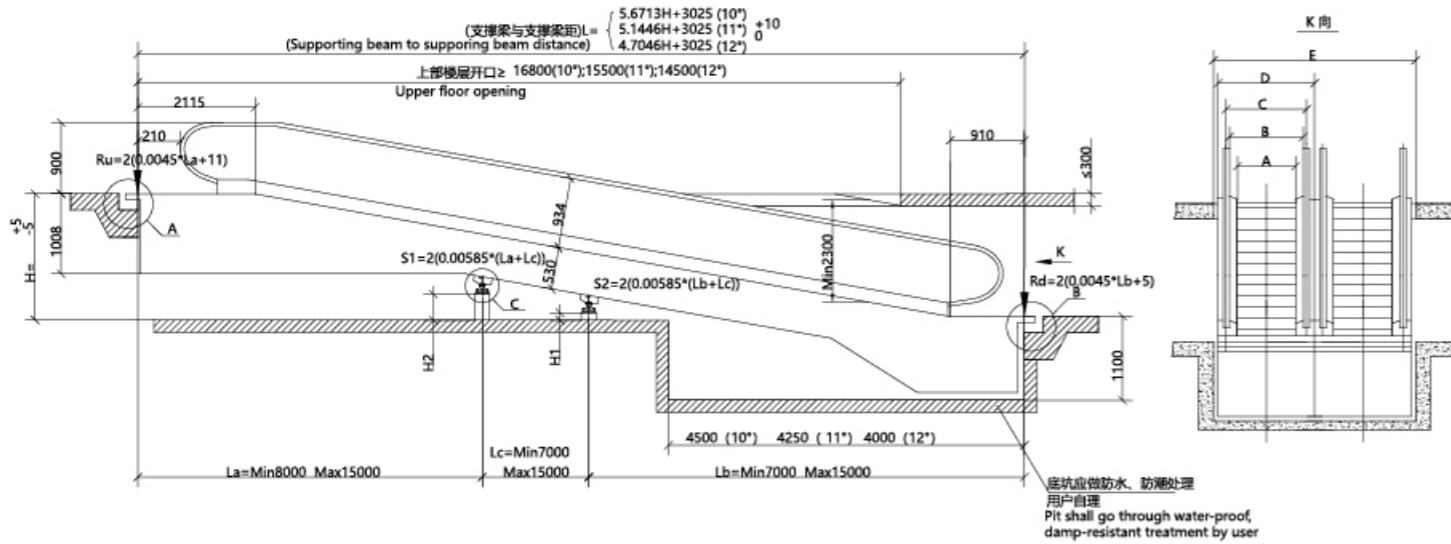

1000	1000	1228	1238	1600	3400
800	800	1028	1038	1400	3000
梯级宽度 mm step width	A	B	C	D	E

提升高度 Traveling height		中间支撑 Intermediate supporting		La(mm)	L b (mm)	L c (mm)
从 From	至 To	S1	S2			
1601	2663					
2664	4151	1		L-7000	7000	
4152	5851	1		15000	L-15000	
5852	6000	1	1	15000	7000	L-22000
A	H2		H1			
10°	H2=H-(La-1995) × 0.1763-840		H1=H2-(Lc × 0.1763)			
11°	H2=H-(La-2055) × 0.1944-840		H1=H2-(Lc × 0.1944)			
12°	H2=H-(La-2115) × 0.2126-840		H1=H2-(Lc × 0.2126)			

注: 当提升高度 > 6m 时, 土建尺寸请咨询我公司 (Note: when traveling height is over 6m, construction size please consult our company)

梯级宽度(mm) step width	提升高度 (mm) Traveling height	速度(m/s) Speed	公称输送容量 (人/h) Rated load capacity	倾斜度 (°) Inclination	曳引机功率(kW) Power	电源容量(KVA) Power supply capacity	电源额定电流(A) Rated current
800	1000-3800	0.5	4800	10,11,12	7.5	15	39
	3800-6000				11	22	58
1000	1000-3000	0.5	6000	10,11,12	7.5	15	39
	3000-4800				11	22	58
	4800-6000				15	30	78

0° MOVING WALK CONSTRUCTION SKETCH

0° 自动人行道土建图

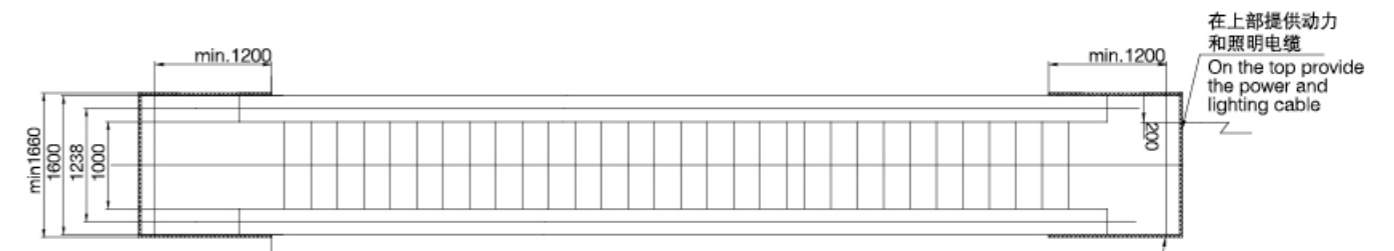
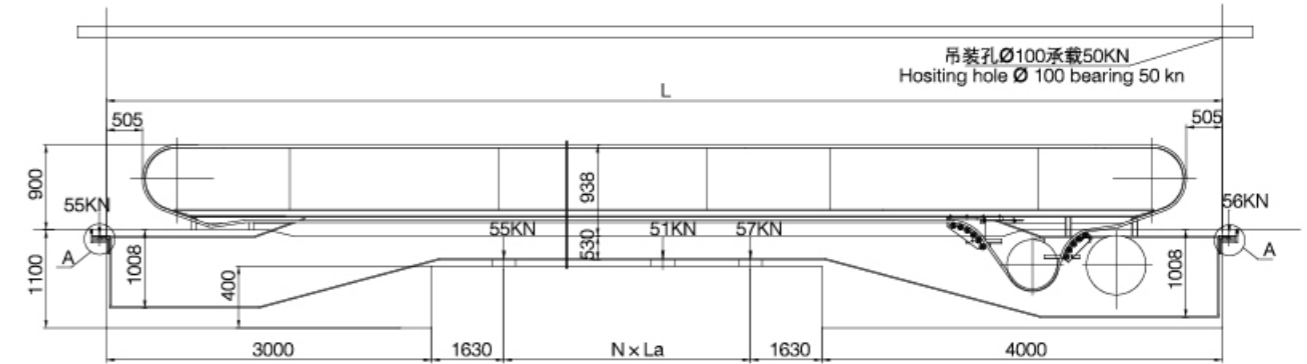

机身与建筑物之间的空隙要充满或盖上, 用户自理并道宽度按采用的规范 (It should fill or cover the gap between the machine and the construction. The user should take care of the standard which is applicable for the well width.)

型号 Model	提升高度 Travelling height(mm)	额定速度 (m/s) Rated speed	理论输送能力 (per./h) Capacity	倾斜角 (°) Inclination	驱动主机 功率 (Kw) Motor power	A (mm)	B (mm)	C (mm)	D (mm)
SD (800/0°-6°)	10000 ≤ H ≤ 80000	0.5	6750	0-6	8	800	1038	1400	≥1460
	80000 < H ≤ 150000				11				
SD (1000/0°-6°)	10000 ≤ H ≤ 70000	0.5	9000	0-6	8	1000	1238	1600	≥1660
	70000 < H ≤ 150000				11				

(本资料仅供设计选用参考, 详细参数以技术图纸为准。)
注: 如超出上述范围的规格, 请与星玛电梯公司联系。
(The data is for design reference only. Regarding detailed parameters, please take technical drawing as criterion.)
Note: If specification exceeds above range, please contact SIGMA Elevator Company.